



## MEMORIA DE CÁLCULO

**OBJETO DEL PROYECTO:** "CONSTRUCCION UCI DEL HOSPITAL SARARE DEL MUNICIPIO DE SARAVENA DEL DEPARTAMENTO DE ARAUCA"

CAPÍTULO	7.1	7.1.01	ITEM	LOCALIZACION Y REPLANTEO REDES HIDRAULICAS HASTA H = 0.50 m	UNID.	M2	UBICACIÓN	HOSPITAL SARARE			
					FECHA	LOCALIZACIÓN	Dimensiones			No. Elemtnos	Medida Total
					LONG	ANCHO	ALTO				
					1000,00				1,00	1000,00	
				<b>SUB-TOTAL EJECUTADO</b>						<b>1.000,00</b>	

**OBSERVACIONES:** la medida en m2 corresponde a la localizacion de replanteo del área de construcción de la Unidad de Cuidados Intensivos.

  
 Julian Camacho Reyes  
 Ing. Civil Usta Tunja Tel:  
 300-7019971

## MEMORIA DE CÁLCULO

**OBJETO DEL PROYECTO** "CONSTRUCCION UCI DEL HOSPITAL SARARE DEL MUNICIPIO DE SARAVERA DEL DEPARTAMENTO DE ARAUCA"

CAPÍTULO	7.1	7.1.02	ITEM	LOCALIZACION Y REPLANTEO REDES SANITARIAS HASTA H = 0.50 m	UNID.	M2	UBICACIÓN	HOSPITAL SARARE			
					FECHA	LOCALIZACIÓN	Dimensiones			No. Elemtnos	Medida Total
LONG	ANCHO	ALTO									
						1718,13				1,00	1718,13
<b>SUB-TOTAL EJECUTADO</b>											<b>1.718,13</b>

**OBSERVACIONES:** la medida en m2 corresponde a la localizacion de replanteo del área de construcción de la Unidad de Cuidados Intensivos. Así como del área calculada donde se ubicará la tubería sanitaria que ira a la red principa desde la edificación.

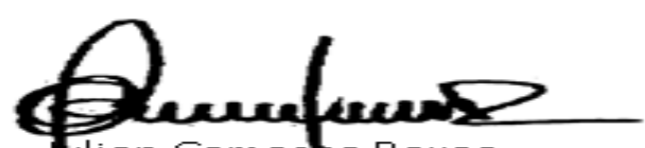
  
 Julian Camacho Reyes  
 Ing: Civil Usta Tunja Tel:  
 300-7019971

# MEMORIA DE CÁLCULO

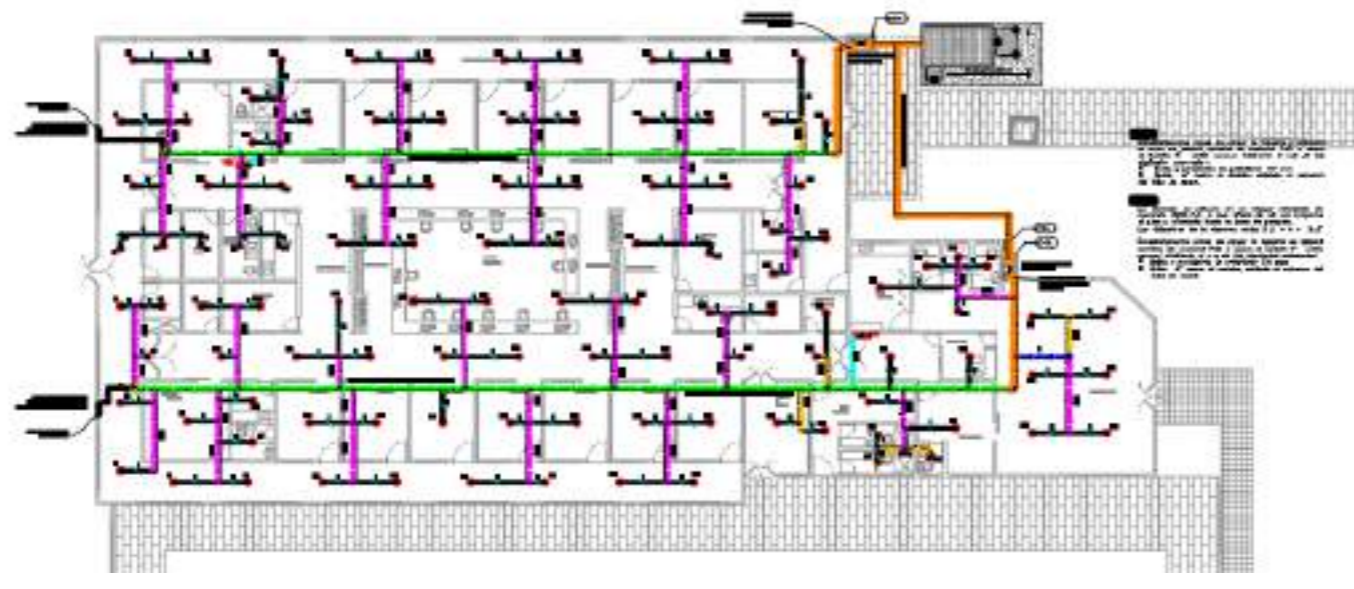

**OBJETO DEL PROYECTO** "CONSTRUCCION UCI DEL HOSPITAL SARARE DEL MUNICIPIO DE SARAVENA DEL DEPARTAMENTO DE ARAUCA"

CAPÍTULO	7.1	7.1.03	ITEM	LOCALIZACION Y REPLANTEO RED CONTRA INCENDIOS HASTA H = 0.50 m	UNID.	M2	UBICACIÓN	HOSPITAL SARARE			
					FECHA	LOCALIZACIÓN	Dimensiones			No. Elemtnos	Medida Total
					LONG	ANCHO	ALTO				
						1000,00				1,00	1000,00
				<b>SUB-TOTAL EJECUTADO</b>							<b>1.000,00</b>

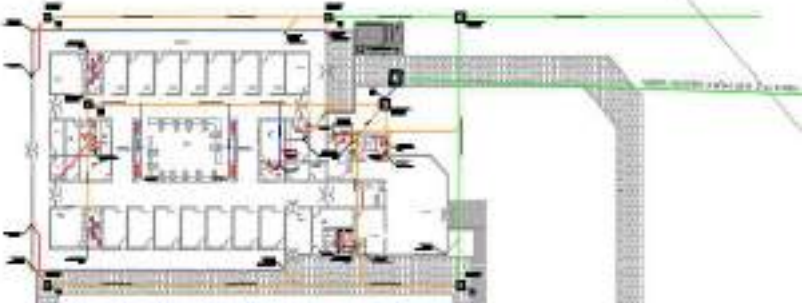

**OBSERVACIONES:** la medida en m2 corresponde a la localizacion de replanteo del área de construcción de la Unidad de Cuidados Intensivos.

  
 Julian Camacho Reyes  
 Ing: Civil Usta Tunja Tel:  
 300-7019971

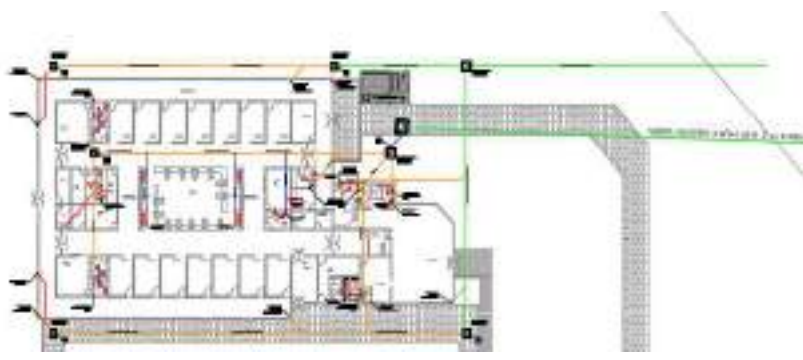

## MEMORIA DE CÁLCULO

OBJETO DEL PROYECTO		<b>"CONSTRUCCION UCI DEL HOSPITAL SARARE DEL MUNICIPIO DE SARAVENA DEL DEPARTAMENTO DE ARAUCA"</b>												
CAPÍTULO	7.2	7.02.01	ITEM	SUMINISTROS E INSTALACIÓN DE MACROMEDIDOR 1" INCLUYE CAJA Y ACCESORIOS	UNID.		UBICACIÓN	HOSPITAL SARARE						
				FECHA	LOCALIZACIÓN	Dimensiones			No. Elemtnos	Medida Total				
						LONG	ANCHO	ALTO						
										1,00	1,00			
				<b>SUB-TOTAL EJECUTADO</b>										<b>1,00</b>
<b>OBSERVACIONES:</b>														
 Julian Camacho Reyes Ing. Civil Usta Tunja Teli 300-7019971														

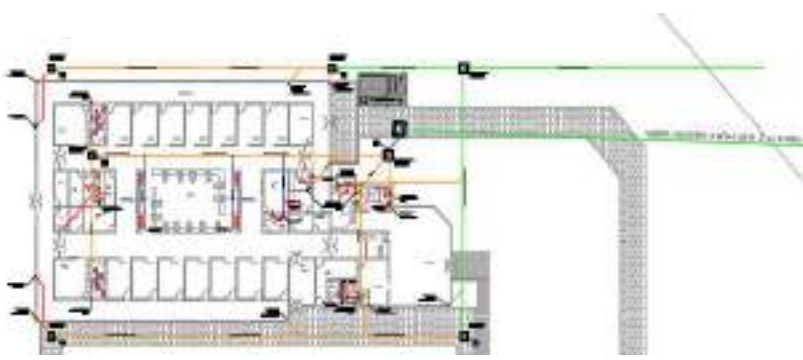

## MEMORIA DE CÁLCULO

OBJETO DEL PROYECTO		<b>"CONSTRUCCION UCI DEL HOSPITAL SARARE DEL MUNICIPIO DE SARAVERA DEL DEPARTAMENTO DE ARAUCA"</b>											
CAPÍTULO	7.2	7.02.02	ITEM	SUMINISTRO E INSTALACIÓN DE COLLARIN DE DERIVACION DE 3" A 1"	UNID.	UND	UBICACIÓN	HOSPITAL SARARE					
				FECHA	LOCALIZACIÓN	Dimensiones			No. Elemtnos	Medida Total			
				LONG	ANCHO	ALTO			1,00	1,00			
													
				<b>SUB-TOTAL EJECUTADO</b>									<b>1,00</b>
OBSERVACIONES:													
 Julian Camacho Reyes Inge. Civil Usta Tunja Telli 300-7019971													

## MEMORIA DE CÁLCULO

OBJETO DEL PROYECTO		<b>"CONSTRUCCION UCI DEL HOSPITAL SARARE DEL MUNICIPIO DE SARAVERA DEL DEPARTAMENTO DE ARAUCA"</b>												
CAPÍTULO	7.2	7.02.03	ITEM	SUMINISTRO E INSTALACIÓN DE CODO 1/2"	UNID.	UND	UBICACIÓN	HOSPITAL SARARE						
				FECHA	LOCALIZACIÓN	Dimensiones			No. Elemtnos	Medida Total				
						LONG	ANCHO	ALTO						
										46,00	46,00			
<b>SUB-TOTAL EJECUTADO</b>										<b>46,00</b>				
OBSERVACIONES:														
 Julian Camacho Reyes Ing. Civil Usta Tunja Telli 300-7019971														

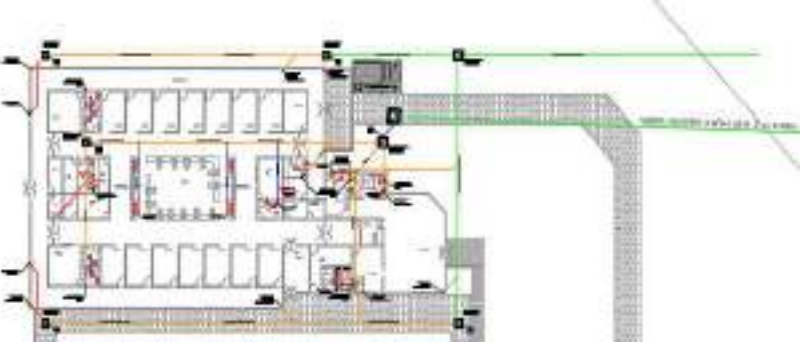
## MEMORIA DE CÁLCULO

OBJETO DEL PROYECTO		<b>"CONSTRUCCION UCI DEL HOSPITAL SARARE DEL MUNICIPIO DE SARAVERA DEL DEPARTAMENTO DE ARAUCA"</b>											
CAPÍTULO	7.2	7.02.04	ITEM	SUMINISTRO E INSTALACION ADAPTADOR DE LIMPIEZA SANTARIO 3"	UNID.	UND	UBICACIÓN	HOSPITAL SARARE					
				FECHA	LOCALIZACIÓN	Dimensiones			No. Elemtnos	Medida Total			
						LONG	ANCHO	ALTO					
										4,00	4,00		
				<b>SUB-TOTAL EJECUTADO</b>						<b>4,00</b>			
OBSERVACIONES:													
 Julian Camacho Reyes Ing. Civil Usta Tunja Telli 300-7019971													

## MEMORIA DE CÁLCULO

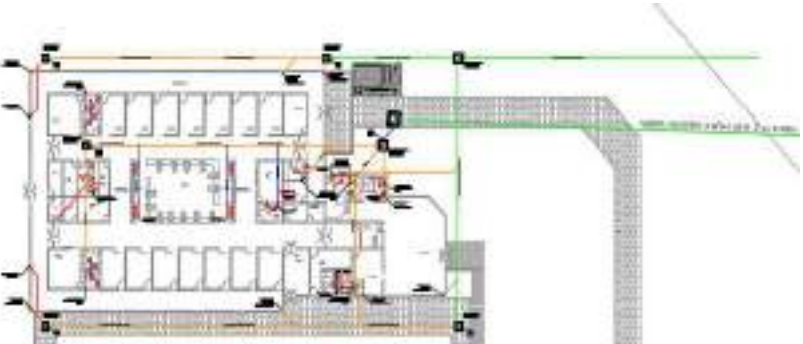

OBJETO DEL PROYECTO		<b>"CONSTRUCCION UCI DEL HOSPITAL SARARE DEL MUNICIPIO DE SARAVERA DEL DEPARTAMENTO DE ARAUCA"</b>												
CAPÍTULO	7.2	7.02.05	ITEM	<b>SUMINISTRO E INSTALACION ADAPTADOR DE LIMPIEZA SANTARIO 4"</b>	UNID.	UND	UBICACIÓN	<b>HOSPITAL SARARE</b>						
				FECHA	LOCALIZACIÓN	Dimensiones			No. Elemtnos	Medida Total				
						LONG	ANCHO	ALTO						
										3,00	3,00			
								<b>SUB-TOTAL EJECUTADO</b>						<b>3,00</b>

OBSERVACIONES:



  
 Julian Camacho Reyes  
 Ing. Civil Usta Tunja Teli  
 300-7019971

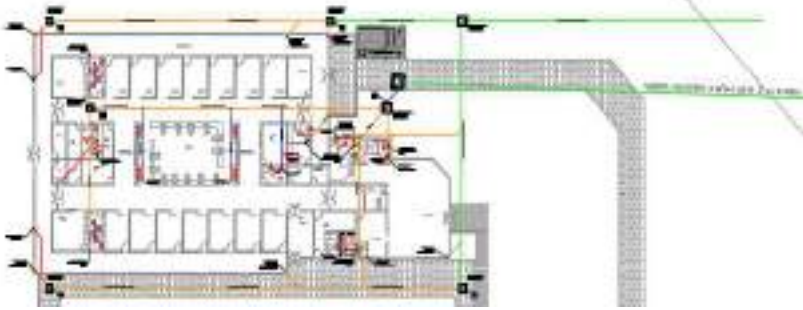



## MEMORIA DE CÁLCULO

OBJETO DEL PROYECTO		<b>"CONSTRUCCION UCI DEL HOSPITAL SARARE DEL MUNICIPIO DE SARAVERA DEL DEPARTAMENTO DE ARAUCA"</b>												
CAPÍTULO	7.2	7.02.06	ITEM	SUMINISTRO E INSTALACIÓN DE BAJANTES 4"	UNID.	ML	UBICACIÓN	HOSPITAL SARARE						
				FECHA	LOCALIZACIÓN	Dimensiones			No. Elemtnos	Medida Total				
						LONG	ANCHO	ALTO						
						40,00				1,00	40,00			
<b>SUB-TOTAL EJECUTADO</b>										<b>40,00</b>				
OBSERVACIONES:														
 Jhian Camacho Reyes Ing. Civil Usta Tunja Telli 300-7019971														

## MEMORIA DE CÁLCULO

OBJETO DEL PROYECTO		<b>"CONSTRUCCION UCI DEL HOSPITAL SARARE DEL MUNICIPIO DE SARAVERENA DEL DEPARTAMENTO DE ARAUCA"</b>											
CAPÍTULO	7.2	7.02.07	ITEM	SUMINISTRO E INSTALACIÓN DE CANAL 4"	UNID.	ML	UBICACIÓN	HOSPITAL SARARE					
				FECHA	LOCALIZACIÓN	Dimensiones			No. Elemtnos	Medida Total			
						LONG	ANCHO	ALTO					
						72,00			1,00	72,00			
				<b>SUB-TOTAL EJECUTADO</b>						<b>72,00</b>			
OBSERVACIONES:													
 Julian Camacho Reyes Ing. Civil Usta Tunja Telli 300-7019971													

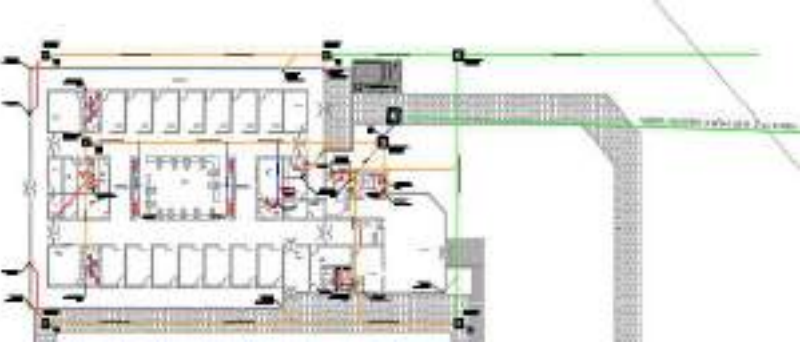
## MEMORIA DE CÁLCULO

OBJETO DEL PROYECTO		<b>"CONSTRUCCION UCI DEL HOSPITAL SARARE DEL MUNICIPIO DE SARAVERA DEL DEPARTAMENTO DE ARAUCA"</b>											
CAPÍTULO	7.2	7.02.08	ITEM	SUMINISTRO E INSTALACIÓN DE CODO 1 1/2"	UNID.	UND	UBICACIÓN	HOSPITAL SARARE					
				FECHA	LOCALIZACIÓN	Dimensiones			No. Elementos	Medida Total			
							LONG	ANCHO	ALTO				
										1,00	1,00		
				<b>SUB-TOTAL EJECUTADO</b>						<b>1,00</b>			
<b>OBSERVACIONES:</b>													
 Julian Camacho Reyes Ing. Civil Usta Tunja Telli 300-7019971													

## MEMORIA DE CÁLCULO

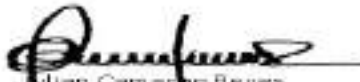
OBJETO DEL PROYECTO		<b>"CONSTRUCCION UCI DEL HOSPITAL SARARE DEL MUNICIPIO DE SARAVERA DEL DEPARTAMENTO DE ARAUCA"</b>												
CAPÍTULO	7.2	7.02.09	ITEM	SUMINISTRO E INSTALACIÓN DE CODO 1"	UNID.	UND	UBICACIÓN	HOSPITAL SARARE						
				FECHA	LOCALIZACIÓN	Dimensiones			No. Elemtnos	Medida Total				
						LONG	ANCHO	ALTO						
										4,00	4,00			
				<b>SUB-TOTAL EJECUTADO</b>						<b>4,00</b>				
OBSERVACIONES:														
 Julian Camacho Reyes Ing. Civil Usta Tunja Teli 300-7019971														

## MEMORIA DE CÁLCULO

OBJETO DEL PROYECTO		"CONSTRUCCION UCI DEL HOSPITAL SARARE DEL MUNICIPIO DE SARAVERENA DEL DEPARTAMENTO DE ARAUCA"											
CAPÍTULO	7.2	7.02.10	ITEM	SUMINISTRO E INSTALACIÓN DE CODO 2"	UNID.	UND	UBICACIÓN	HOSPITAL SARARE					
				FECHA	LOCALIZACIÓN	Dimensiones			No. Elemtnos	Medida Total			
						LONG	ANCHO	ALTO					
										3,00	3,00		
				<b>SUB-TOTAL EJECUTADO</b>									



OBSERVACIONES:

  
 Julian Camacho Reyes  
 Ing. Civil Usta Tunja Teli  
 300-7019971

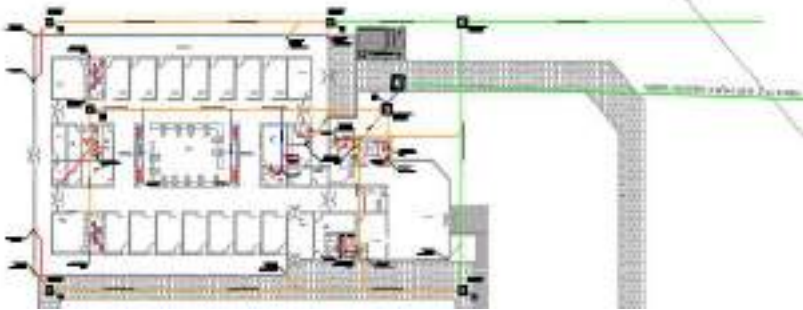
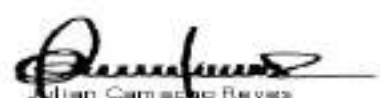
## MEMORIA DE CÁLCULO

OBJETO DEL PROYECTO		<b>"CONSTRUCCION UCI DEL HOSPITAL SARARE DEL MUNICIPIO DE SARAVENA DEL DEPARTAMENTO DE ARAUCA"</b>											
CAPÍTULO	7.2	7.02.11	ITEM	SUMINISTRO E INSTALACIÓN DE CODO 3/4"	UNID.	UND	UBICACIÓN	HOSPITAL SARARE					
				FECHA	LOCALIZACIÓN	Dimensiones			No. Elemtnos	Medida Total			
						LONG	ANCHO	ALTO					
										35,00	35,00		
				<b>SUB-TOTAL EJECUTADO</b>						<b>35,00</b>			
OBSERVACIONES:													
 Julian Camacho Reyes Ing. Civil Usta Tunja Telli 300-7019971													

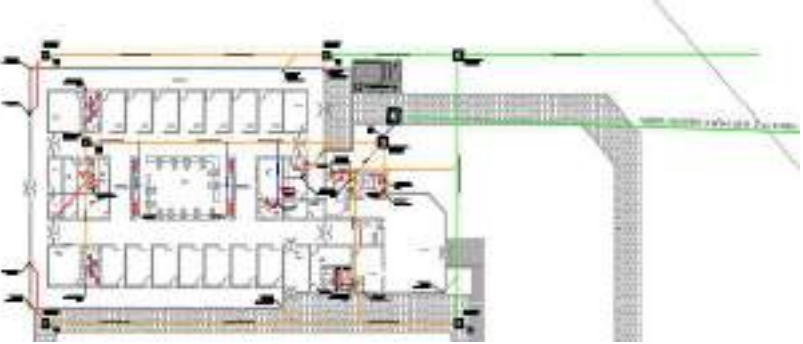
## MEMORIA DE CÁLCULO

OBJETO DEL PROYECTO		<b>"CONSTRUCCION UCI DEL HOSPITAL SARARE DEL MUNICIPIO DE SARAVENA DEL DEPARTAMENTO DE ARAUCA"</b>											
CAPÍTULO	7.2	7.02.12	ITEM	SUMINISTRO E INSTALACIÓN DE TEE 1 1/2"	UNID.	UND	UBICACIÓN	HOSPITAL SARARE					
				FECHA	LOCALIZACIÓN	Dimensiones			No. Elementos	Medida Total			
						LONG	ANCHO	ALTO					
										2,00	2,00		
<b>SUB-TOTAL EJECUTADO</b>										<b>2,00</b>			
OBSERVACIONES:													
 Julian Camacho Reyes Ing. Civil Usta Tunja Teli: 300-7019971													

## MEMORIA DE CÁLCULO

OBJETO DEL PROYECTO "CONSTRUCCION UCI DEL HOSPITAL SARARE DEL MUNICIPIO DE SARAVENA DEL DEPARTAMENTO DE ARAUCA"

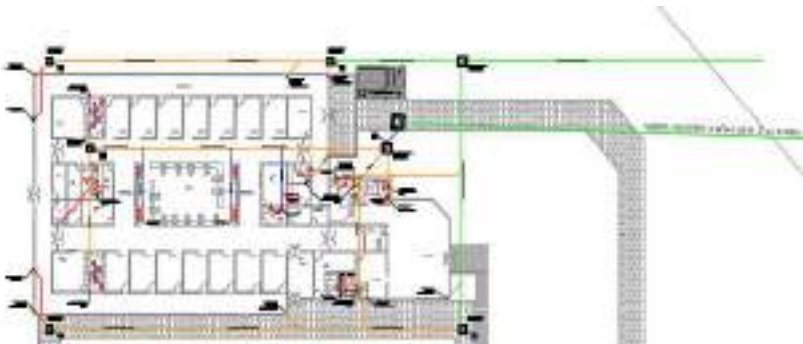

CAPÍTULO	7.2	7.02.13	ITEM	SUMINISTRO E INSTALACIÓN DE TEE 1"	UNID.	UND	UBICACIÓN	HOSPITAL SARARE				
				FECHA	LOCALIZACIÓN	Dimensiones			No. Elementos	Medida Total		
						LONG	ANCHO	ALTO				
									8,00	8,00		
				<b>SUB-TOTAL EJECUTADO</b>								

OBSERVACIONES:

  
 Julian Camacho Reyes  
 Ing. Civil Usta Tunja Teli  
 300-7019971

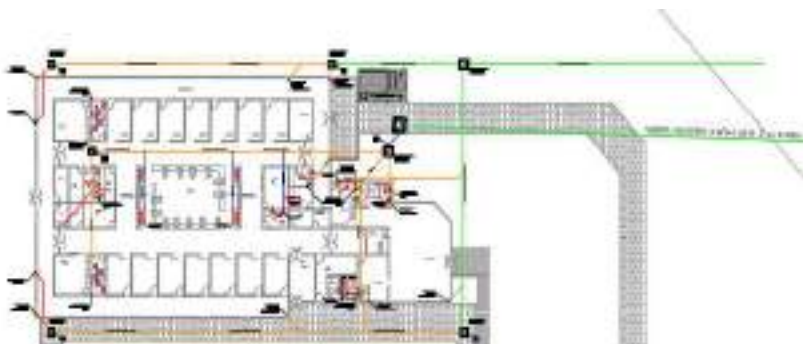

## MEMORIA DE CÁLCULO

OBJETO DEL PROYECTO		<b>"CONSTRUCCION UCI DEL HOSPITAL SARARE DEL MUNICIPIO DE SARAVERA DEL DEPARTAMENTO DE ARAUCA"</b>												
CAPÍTULO	7.2	7.02.14	ITEM	SUMINISTRO E INSTALACIÓN DE TEE 1/2"	UNID.	UND	UBICACIÓN	HOSPITAL SARARE						
				FECHA	LOCALIZACIÓN	Dimensiones			No. Elementos	Medida Total				
						LONG	ANCHO	ALTO						
										25,00	25,00			
<b>SUB-TOTAL EJECUTADO</b>										<b>25,00</b>				
OBSERVACIONES:														
 Julian Camacho Reyes Ing. Civil Usta Tunja Teli 300-7019971														

## MEMORIA DE CÁLCULO

OBJETO DEL PROYECTO: "CONSTRUCCION UCI DEL HOSPITAL SARARE DEL MUNICIPIO DE SARAVERA DEL DEPARTAMENTO DE ARAUCA"

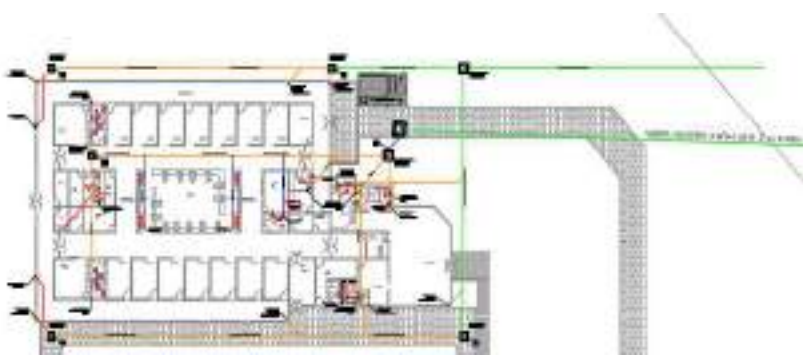
CAPÍTULO	7.2	7.02.15	ITEM	SUMINISTRO E INSTALACIÓN DE TEE 2"	UNID.	UND	UBICACIÓN	HOSPITAL SARARE				
				FECHA	LOCALIZACIÓN	Dimensiones			No. Elementos	Medida Total		
						LONG	ANCHO	ALTO				
									5,00	5,00		
				<b>SUB-TOTAL EJECUTADO</b>								

OBSERVACIONES:

  
 Julian Camacho Reyes  
 Ing. Civil Usta Tunja Teli  
 300-7019971

## MEMORIA DE CÁLCULO

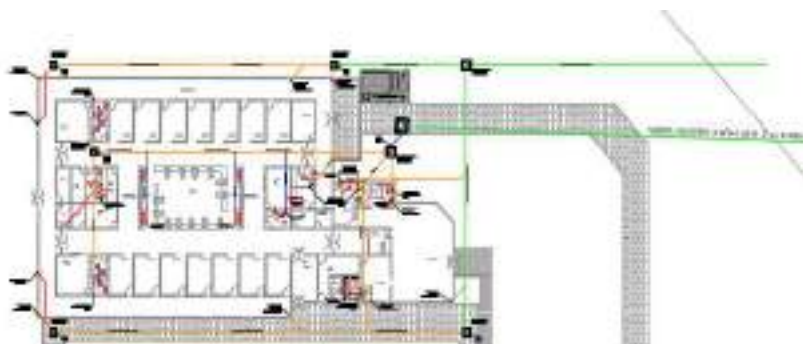

OBJETO DEL PROYECTO "CONSTRUCCION UCI DEL HOSPITAL SARARE DEL MUNICIPIO DE SARAVENA DEL DEPARTAMENTO DE ARAUCA"

CAPÍTULO	7.2	7.02.16	ITEM	SUMINISTRO E INSTALACIÓN DE TEE 3/4"	UNID.	UND	UBICACIÓN	HOSPITAL SARARE				
				FECHA	LOCALIZACIÓN	Dimensiones			No. Elemtnos	Medida Total		
						LONG	ANCHO	ALTO				
									25,00	25,00		
				<b>SUB-TOTAL EJECUTADO</b>								

OBSERVACIONES:

  
 Julian Camacho Reyes  
 Ing. Civil Usta Tunja Teli  
 300-7019971

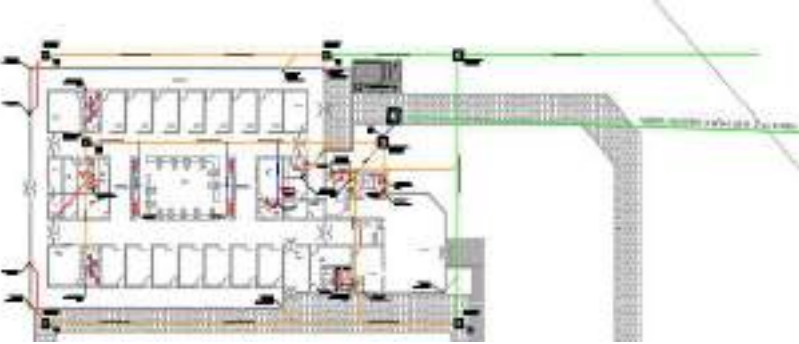

## MEMORIA DE CÁLCULO

OBJETO DEL PROYECTO		<b>"CONSTRUCCION UCI DEL HOSPITAL SARARE DEL MUNICIPIO DE SARAVERA DEL DEPARTAMENTO DE ARAUCA"</b>												
CAPÍTULO	7.2	7.02.17	ITEM	SUMINISTRO E INSTALACIÓN DE TUBO DE 1 1/2"	UNID.	ML	UBICACIÓN	HOSPITAL SARARE						
				FECHA	LOCALIZACIÓN	Dimensiones			No. Elementos	Medida Total				
							LONG	ANCHO	ALTO					
							6,00			1,00	6,00			
<b>SUB-TOTAL EJECUTADO</b>									<b>6,00</b>					
<b>OBSERVACIONES:</b>														
 Julian Camacho Reyes Ing. Civil Usta Tunja Tels: 300-7019971														

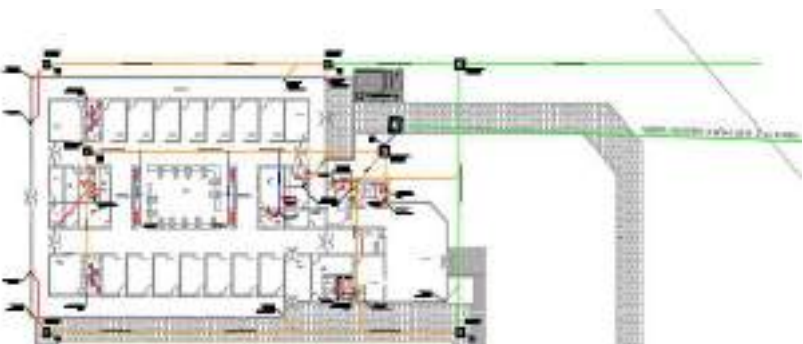
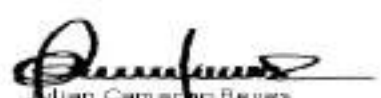

## MEMORIA DE CÁLCULO

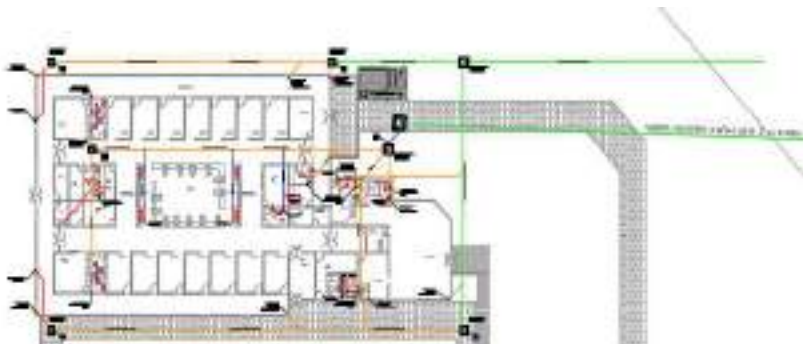
OBJETO DEL PROYECTO		<b>"CONSTRUCCION UCI DEL HOSPITAL SARARE DEL MUNICIPIO DE SARAVERA DEL DEPARTAMENTO DE ARAUCA"</b>												
CAPÍTULO	7.2	7.02.18	ITEM	SUMINISTRO E INSTALACIÓN DE TUBO DE 1"	UNID.	ML	UBICACIÓN	HOSPITAL SARARE						
				FECHA	LOCALIZACIÓN	Dimensiones			No. Elementos	Medida Total				
						LONG	ANCHO	ALTO						
						27,84			1,00	27,84				
				<b>SUB-TOTAL EJECUTADO</b>						<b>27,84</b>				
OBSERVACIONES:														
 Julian Camacho Reyes Ing. Civil Usta Tunja Teli 300-7019971														

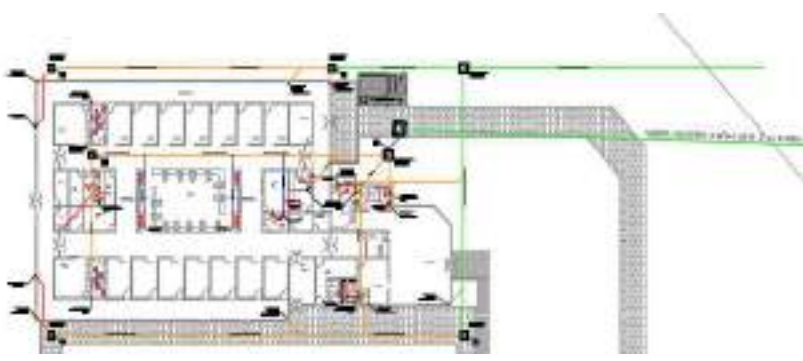

## MEMORIA DE CÁLCULO

OBJETO DEL PROYECTO		<b>"CONSTRUCCION UCI DEL HOSPITAL SARARE DEL MUNICIPIO DE SARAVERENA DEL DEPARTAMENTO DE ARAUCA"</b>												
CAPÍTULO	7.2	7.02.19	ITEM	SUMINISTRO E INSTALACIÓN DE TUBO DE 1/2"	UNID.	ML	UBICACIÓN	HOSPITAL SARARE						
				FECHA	LOCALIZACIÓN	Dimensiones			No. Elementos	Medida Total				
						LONG	ANCHO	ALTO						
						17,97				1,00	17,97			
<b>SUB-TOTAL EJECUTADO</b>										<b>17,97</b>				
OBSERVACIONES:														
 Julian Camacho Reyes Ing. Civil Usta Tunja Teli 300-7019971														

## MEMORIA DE CÁLCULO

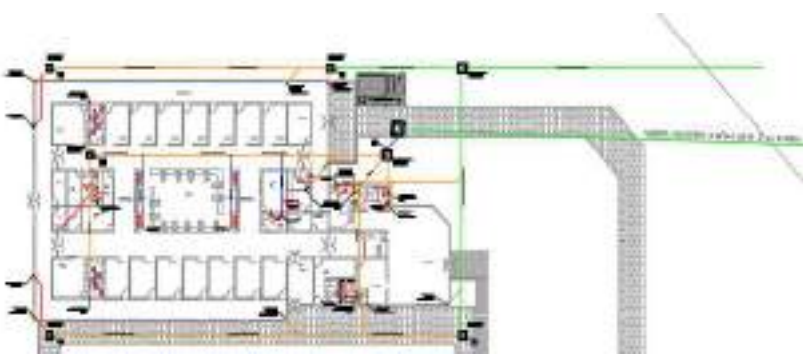

OBJETO DEL PROYECTO		<b>"CONSTRUCCION UCI DEL HOSPITAL SARARE DEL MUNICIPIO DE SARAVERA DEL DEPARTAMENTO DE ARAUCA"</b>											
CAPÍTULO	7.2	7.02.20	ITEM	SUMINISTRO E INSTALACIÓN DE TUBO DE 2"	UNID.	ML	UBICACIÓN	HOSPITAL SARARE					
				FECHA	LOCALIZACIÓN	Dimensiones			No. Elementos	Medida Total			
						LONG	ANCHO	ALTO					
						44,50				1,00	44,50		
<b>SUB-TOTAL EJECUTADO</b>										<b>44,50</b>			
OBSERVACIONES:													
 Julian Camacho Reyes Ing. Civil Usta Tunja Teli 300-7019971													

## MEMORIA DE CÁLCULO



OBJETO DEL PROYECTO		<b>"CONSTRUCCION UCI DEL HOSPITAL SARARE DEL MUNICIPIO DE SARAVERA DEL DEPARTAMENTO DE ARAUCA"</b>												
CAPÍTULO	7.2	7.02.21	ITEM	SUMINISTRO E INSTALACIÓN DE TUBO DE 3/4"	UNID.	ML	UBICACIÓN	HOSPITAL SARARE						
				FECHA	LOCALIZACIÓN	Dimensiones			No. Elementos	Medida Total				
						LONG	ANCHO	ALTO						
						55,66			1,00	55,66				
								<b>SUB-TOTAL EJECUTADO</b>						<b>55,66</b>
OBSERVACIONES:														
 Julian Camacho Reyes Ing. Civil Usta Tunja Teli 300-7019971														

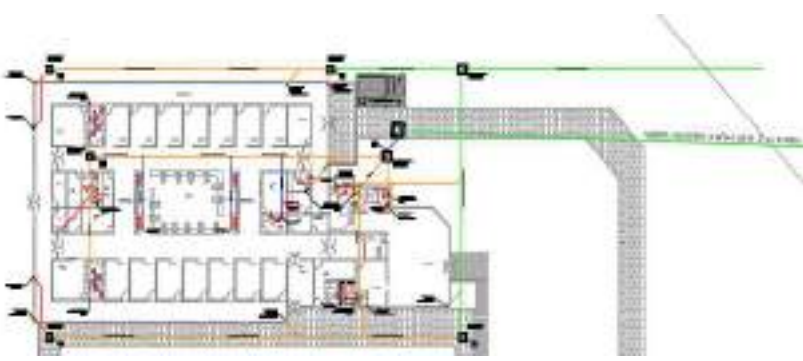

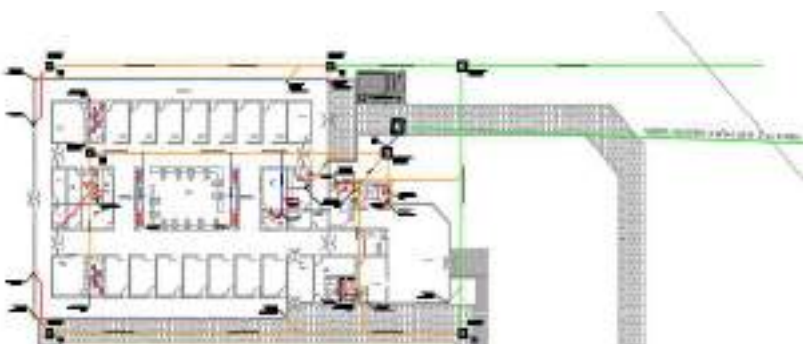

## MEMORIA DE CÁLCULO

OBJETO DEL PROYECTO		<b>"CONSTRUCCION UCI DEL HOSPITAL SARARE DEL MUNICIPIO DE SARAVERENA DEL DEPARTAMENTO DE ARAUCA"</b>												
CAPÍTULO	7.2	7.02.22	ITEM	SUMINISTRO E INSTALACIÓN DE TUBO SANITARIO 2"	UNID.		ML	UBICACIÓN	HOSPITAL SARARE					
				FECHA	LOCALIZACIÓN	Dimensiones			No. Elementos	Medida Total				
						LONG	ANCHO	ALTO						
						38,12				1,00	38,12			
<b>SUB-TOTAL EJECUTADO</b>										<b>38,12</b>				
OBSERVACIONES:														
 Julian Camacho Reyes Ing. Civil Usta Tunja Teli 300-7019971														

## MEMORIA DE CÁLCULO

OBJETO DEL PROYECTO		<b>"CONSTRUCCION UCI DEL HOSPITAL SARARE DEL MUNICIPIO DE SARAVERA DEL DEPARTAMENTO DE ARAUCA"</b>											
CAPÍTULO	7.2	7.02.23	ITEM	SUMINISTRO E INSTALACIÓN DE TUBO SANITARIO 3"	UNID.	ML	UBICACIÓN	HOSPITAL SARARE					
				FECHA	LOCALIZACIÓN	Dimensiones			No. Elementos	Medida Total			
							LONG	ANCHO	ALTO				
						26,38				1,00	26,38		
				<b>SUB-TOTAL EJECUTADO</b>						<b>26,38</b>			
OBSERVACIONES:													
 Julian Camacho Reyes Ing. Civil Usta Tunja Teli 300-7019971													

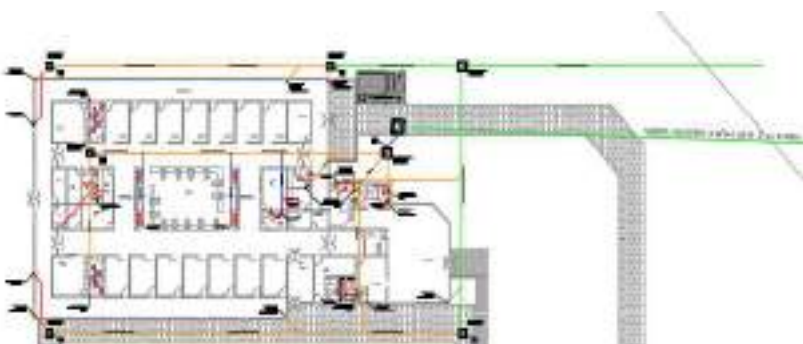

## MEMORIA DE CÁLCULO

OBJETO DEL PROYECTO		<b>"CONSTRUCCION UCI DEL HOSPITAL SARARE DEL MUNICIPIO DE SARAVERA DEL DEPARTAMENTO DE ARAUCA"</b>												
CAPÍTULO	7.2	7.02.24	ITEM	SUMINISTRO E INSTALACIÓN DE TUBO SANITARIO 4"	UNID.		ML	UBICACIÓN	HOSPITAL SARARE					
				FECHA	LOCALIZACIÓN	Dimensiones			No. Elementos	Medida Total				
						LONG	ANCHO	ALTO						
						102,41				1,00	102,41			
<b>SUB-TOTAL EJECUTADO</b>										<b>102,41</b>				
<b>OBSERVACIONES:</b>														
 Julian Camacho Reyes Ing. Civil Usta Tunja Tels: 300-7019971														

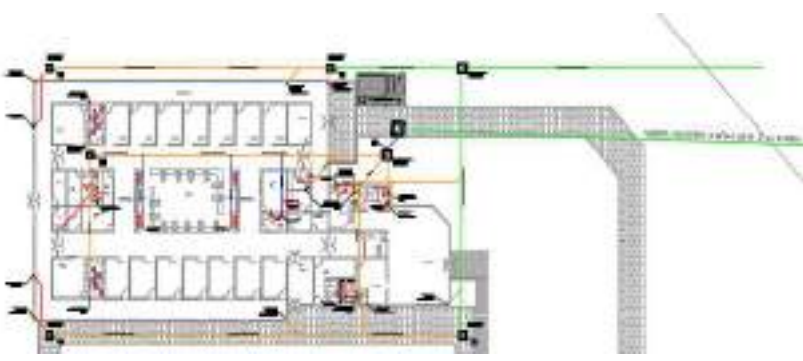
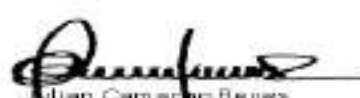
## MEMORIA DE CÁLCULO

OBJETO DEL PROYECTO		<b>"CONSTRUCCION UCI DEL HOSPITAL SARARE DEL MUNICIPIO DE SARAVERA DEL DEPARTAMENTO DE ARAUCA"</b>												
CAPÍTULO	7.2	7.02.25	ITEM	UNIONES DE CANAL	UNID.	UND	UBICACIÓN	HOSPITAL SARARE						
				FECHA	LOCALIZACIÓN	Dimensiones			No. Elementos	Medida Total				
						LONG	ANCHO	ALTO						
										24,00	24,00			
				<b>SUB-TOTAL EJECUTADO</b>						<b>24,00</b>				
OBSERVACIONES:														
 Julian Camacho Reyes Ing. Civil Usta Tunja Telli 300-7019971														

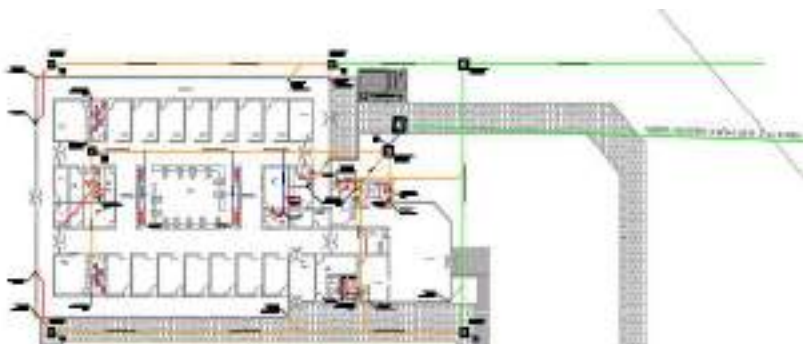
## MEMORIA DE CÁLCULO

OBJETO DEL PROYECTO		<b>"CONSTRUCCION UCI DEL HOSPITAL SARARE DEL MUNICIPIO DE SARAVERA DEL DEPARTAMENTO DE ARAUCA"</b>											
CAPÍTULO	7.2	7.02.26	ITEM	UNIONES DE ESQUINA	UNID.	UND	UBICACIÓN	HOSPITAL SARARE					
				FECHA	LOCALIZACIÓN	Dimensiones			No. Elementos	Medida Total			
						LONG	ANCHO	ALTO					
										4,00	4,00		
				<b>SUB-TOTAL EJECUTADO</b>						<b>4,00</b>			
OBSERVACIONES:													
 Julian Camacho Reyes Inge. Civil Usta Tunja Tels: 300-7019971													

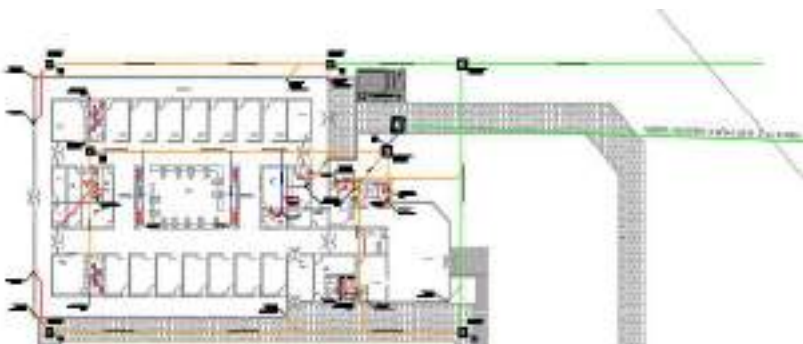

## MEMORIA DE CÁLCULO

OBJETO DEL PROYECTO		<b>"CONSTRUCCION UCI DEL HOSPITAL SARARE DEL MUNICIPIO DE SARAVENA DEL DEPARTAMENTO DE ARAUCA"</b>												
CAPÍTULO	7.2	7.02.27	ITEM	SUMINISTRO E INSTALACIÓN DE YEE SANITARIA 2"	UNID.	UND	UBICACIÓN	HOSPITAL SARARE						
				FECHA	LOCALIZACIÓN	Dimensiones			No. Elementos	Medida Total				
						LONG	ANCHO	ALTO						
										14,00	14,00			
				<b>SUB-TOTAL EJECUTADO</b>										<b>14,00</b>

OBSERVACIONES:

  
 Julian Camacho Reyes  
 Ing. Civil Usta Tunja Tel:  
 300-7019971

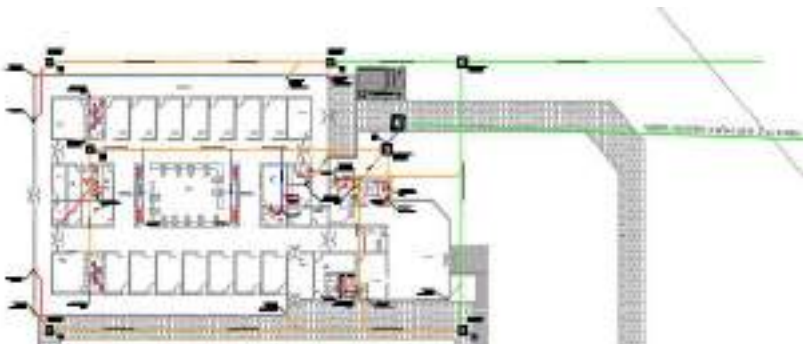
## MEMORIA DE CÁLCULO

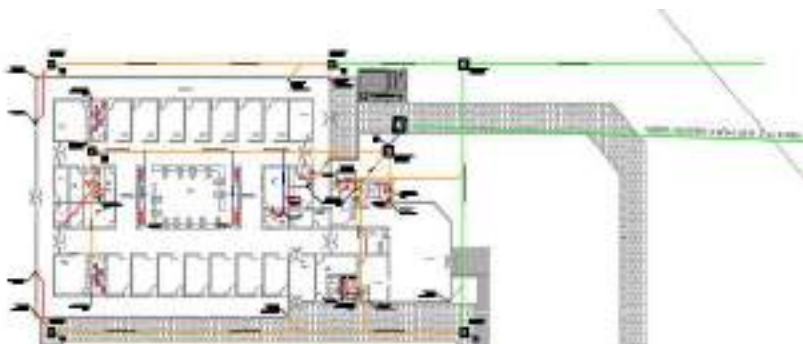
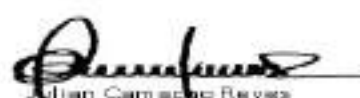

OBJETO DEL PROYECTO		<b>"CONSTRUCCION UCI DEL HOSPITAL SARARE DEL MUNICIPIO DE SARAVENA DEL DEPARTAMENTO DE ARAUCA"</b>												
CAPÍTULO	7.2	7.02.28	ITEM	SUMINISTRO E INSTALACIÓN DE YEE SANITARIA 3"	UNID.	UND	UBICACIÓN	HOSPITAL SARARE						
				FECHA	LOCALIZACIÓN	Dimensiones			No. Elemtnos	Medida Total				
						LONG	ANCHO	ALTO						
										20,00	20,00			
<b>SUB-TOTAL EJECUTADO</b>										<b>20,00</b>				
OBSERVACIONES:														
 Julian Camacho Reyes Ing. Civil Usta Tunja Teli 300-7019971														

## MEMORIA DE CÁLCULO

OBJETO DEL PROYECTO		<b>"CONSTRUCCION UCI DEL HOSPITAL SARARE DEL MUNICIPIO DE SARAVENA DEL DEPARTAMENTO DE ARAUCA"</b>												
CAPÍTULO	7.2	7.02.29	ITEM	SUMINISTRO E INSTALACIÓN DE YEE SANITARIA 4"	UNID.	UND	UBICACIÓN	HOSPITAL SARARE						
				FECHA	LOCALIZACIÓN	Dimensiones			No. Elementos	Medida Total				
						LONG	ANCHO	ALTO						
										30,00	30,00			
				<b>SUB-TOTAL EJECUTADO</b>						<b>30,00</b>				
OBSERVACIONES:														
 Julian Camacho Reyes Ing. Civil Usta Tunja Teli 300-7019971														

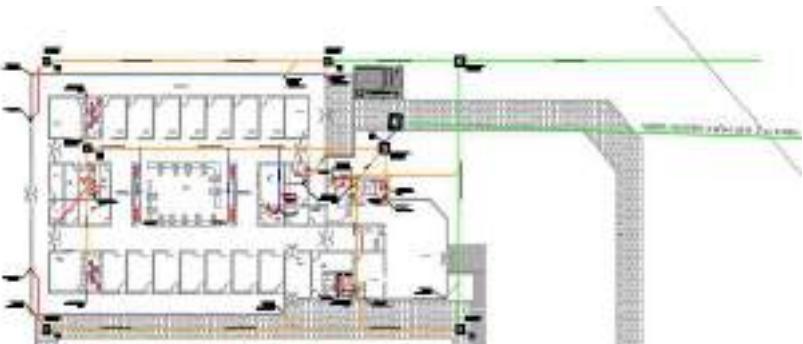

## MEMORIA DE CÁLCULO

OBJETO DEL PROYECTO		<b>"CONSTRUCCION UCI DEL HOSPITAL SARARE DEL MUNICIPIO DE SARAVERA DEL DEPARTAMENTO DE ARAUCA"</b>											
CAPÍTULO	7.2	7.02.30	ITEM	ARENA PARA LECHO FILTRANTE (CANTO RODADO % SILICE <99, CE = (0.7 - 0.9), % SOLUBILIDAD HCI < 4%, COEFICIENTE	UNID.	M3	UBICACIÓN	HOSPITAL SARARE					
				FECHA	LOCALIZACIÓN	Dimensiones			No. Elementos	Medida Total			
						LONG	ANCHO	ALTO					
						5,20				1,00	5,20		
<b>SUB-TOTAL EJECUTADO</b>										<b>5,20</b>			
OBSERVACIONES:													
 Julian Camacho Reyes Ing. Civil Usta Tunja Teli 300-7019971													

## MEMORIA DE CÁLCULO

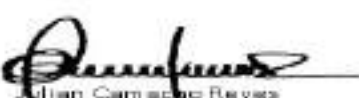
OBJETO DEL PROYECTO		<b>"CONSTRUCCION UCI DEL HOSPITAL SARARE DEL MUNICIPIO DE SARAVERA DEL DEPARTAMENTO DE ARAUCA"</b>												
CAPÍTULO	7.2	7.02.31	ITEM	SUMINISTRO E INSTALACION DE ACCESORIO SIFON EN PVC	UNID.	UND	UBICACIÓN	HOSPITAL SARARE						
				FECHA	LOCALIZACIÓN	Dimensiones			No. Elemtnos	Medida Total				
						LONG	ANCHO	ALTO						
										12,00	12,00			
<b>SUB-TOTAL EJECUTADO</b>										<b>12,00</b>				
OBSERVACIONES:														
 Julian Camacho Reyes Ing. Civil Usta Tunja Teli 300-7019971														

## MEMORIA DE CÁLCULO

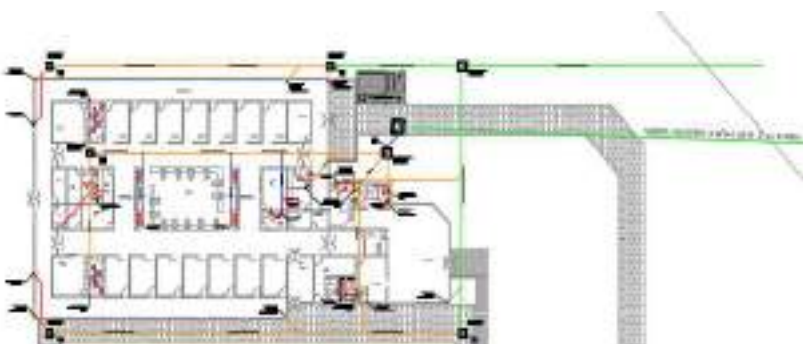
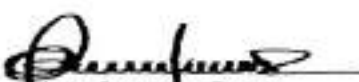
OBJETO DEL PROYECTO		<b>"CONSTRUCCION UCI DEL HOSPITAL SARARE DEL MUNICIPIO DE SARAVERA DEL DEPARTAMENTO DE ARAUCA"</b>												
CAPÍTULO	7.2	7.02.32	ITEM	SUMINISTRO E INSTALACION DE ACCESORIO SIFON DE CUPULA	UNID.	UND	UBICACIÓN	HOSPITAL SARARE						
				FECHA	LOCALIZACIÓN	Dimensiones			No. Elemtnos	Medida Total				
						LONG	ANCHO	ALTO						
										23,00	23,00			
				<b>SUB-TOTAL EJECUTADO</b>										<b>23,00</b>
OBSERVACIONES:														
 Julian Camacho Reyes Ing. Civil Usta Tunja Tels: 300-7019971														

## MEMORIA DE CÁLCULO

**OBJETO DEL PROYECTO** "CONSTRUCCION UCI DEL HOSPITAL SARARE DEL MUNICIPIO DE SARAVERA DEL DEPARTAMENTO DE ARAUCA"

CAPÍTULO	7.2	7.02.33	ITEM	CAJA DE INSPECCIÓN EN MAMPOSTERÍA MEDIDAS INTERNAS DE 0,6X0,6X0,6 M TAPA EN FC DE 3500 PSI EN DOS MÓDULOS CON TERMINALES	UNID.	UND	UBICACIÓN	HOSPITAL SARARE			
				FECHA	LOCALIZACIÓN	Dimensiones			No. Elemtnos	Medida Total	
						LONG	ANCHO	ALTO	5,00	5,00	
				<b>SUB-TOTAL EJECUTADO</b>							

OBSERVACIONES:

  
 Julian Camacho Reyes  
 Ing. Civil Usta Tunja Telli  
 300-7019971

## MEMORIA DE CÁLCULO

**OBJETO DEL PROYECTO** "CONSTRUCCION UCI DEL HOSPITAL SARARE DEL MUNICIPIO DE SARAVENA DEL DEPARTAMENTO DE ARAUCA"

CAPÍTULO	7.2	7.02.34	ITEM	CAJA DE INSPECCIÓN EN MAMPOSTERÍA MEDIDAS INTERNAS DE 0,8X0,8X0,8 M TAPA EN FC DE 3500 PSI EN DOS MÓDULOS CON TERMINALES	UNID.	UND	UBICACIÓN	HOSPITAL SARARE
----------	-----	---------	------	---	-------	-----	-----------	-----------------

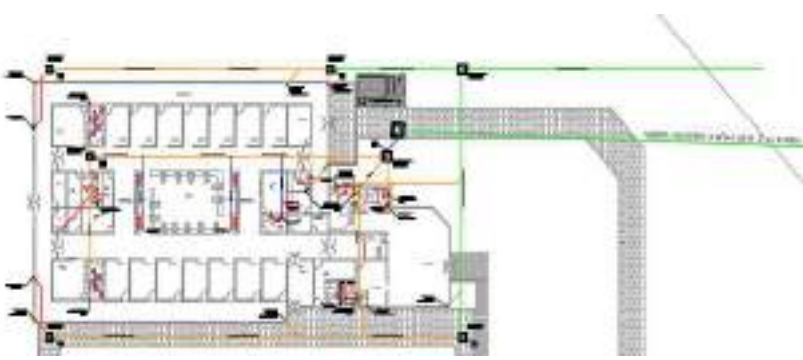
	FECHA	LOCALIZACIÓN	Dimensiones			No. Elementos	Medida Total
			LONG	ANCHO	ALTO		
						3,00	3,00
	<b>SUB-TOTAL EJECUTADO</b>						<b>3,00</b>

**OBSERVACIONES:**

  
 Julian Camacho Reyes  
 Ing. Civil Usta Tunja Teli  
 300-7019971

## MEMORIA DE CÁLCULO

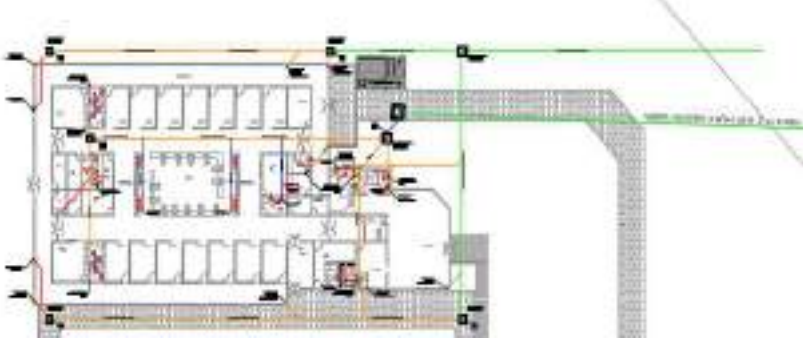
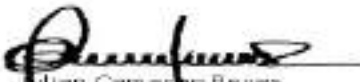
OBJETO DEL PROYECTO		<b>"CONSTRUCCION UCI DEL HOSPITAL SARARE DEL MUNICIPIO DE SARAVENA DEL DEPARTAMENTO DE ARAUCA"</b>											
CAPÍTULO	7.2	7.02.35	ITEM	CAJA DE INSPECCIÓN EN MAMPOSTERÍA MEDIDAS INTERNAS DE 1X1X1 M TAPA EN FC DE 3500 PSI EN DOS MÓDULOS CON TERMINALES	UNID.	UND	UBICACIÓN	HOSPITAL SARARE					
				FECHA	LOCALIZACIÓN	Dimensiones			No. Elementos	Medida Total			
						LONG	ANCHO	ALTO					
									1,00	1,00			
				<b>SUB-TOTAL EJECUTADO</b>									<b>1,00</b>
<b>OBSERVACIONES:</b>													
 Julian Camacho Reyes Ing. Civil Usta Tunja Telli 300-7019971													

## MEMORIA DE CÁLCULO

OBJETO DEL PROYECTO



**"CONSTRUCCION UCI DEL HOSPITAL SARARE DEL MUNICIPIO DE SARAVENA DEL DEPARTAMENTO DE ARAUCA"**

CAPÍTULO	7.3	7.03.01	ITEM	MT TUBO 3 ACERO C/C SCH10 RAN ROJA	UNID.	ML	UBICACIÓN	HOSPITAL SARARE					
				FECHA	LOCALIZACIÓN	Dimensiones			No. Elementos	Medida Total			
						LONG	ANCHO	ALTO					
						73,48			1,00	73,48			
				<b>SUB-TOTAL EJECUTADO</b>									<b>73,48</b>

OBSERVACIONES:



  
 Julian Camacho Reyes  
 Ing. Civil Usta Tunja Tels:  
 300-7019971

## MEMORIA DE CÁLCULO

OBJETO DEL PROYECTO		<b>"CONSTRUCCION UCI DEL HOSPITAL SARARE DEL MUNICIPIO DE SARAVENA DEL DEPARTAMENTO DE ARAUCA"</b>											
CAPÍTULO	7.3	7.03.02	ITEM	MT TUBO 1 1/2 ACERO C/C SCH10 RAN ROJA	UNID.	ML	UBICACIÓN	HOSPITAL SARARE					
				FECHA	LOCALIZACIÓN	Dimensiones			No. Elementos	Medida Total			
						LONG	ANCHO	ALTO					
						89,47			1,00	89,47			
				<b>SUB-TOTAL EJECUTADO</b>						<b>89,47</b>			
OBSERVACIONES:													
 Julian Camacho Reyes Ing. Civil Usta Tunja Teli 300-7019971													



## MEMORIA DE CÁLCULO

OBJETO DEL PROYECTO		<b>"CONSTRUCCION UCI DEL HOSPITAL SARARE DEL MUNICIPIO DE SARAVENA DEL DEPARTAMENTO DE ARAUCA"</b>											
CAPÍTULO	7.3	7.03.03	ITEM	MT TUBO 2 1/2 ACERO C/C SCH10 RAN ROJA	UNID.	ML	UBICACIÓN	HOSPITAL SARARE					
				FECHA	LOCALIZACIÓN	Dimensiones			No. Elementos	Medida Total			
						LONG	ANCHO	ALTO					
						6,00			1,00	6,00			
<b>SUB-TOTAL EJECUTADO</b>									<b>6,00</b>				
OBSERVACIONES:													
 Julian Camacho Reyes Ing. Civil Usta Tunja Tels: 300-7019971													

## MEMORIA DE CÁLCULO

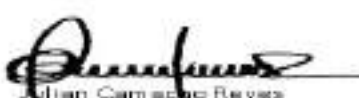
OBJETO DEL PROYECTO										
"CONSTRUCCION UCI DEL HOSPITAL SARARE DEL MUNICIPIO DE SARAVENA DEL DEPARTAMENTO DE ARAUCA"										
CAPÍTULO	7.3	7.03.04	ITEM	MT TUBO 1 ACERO C/C SCH 40 RAN ROJA	UNID.	ML	UBICACIÓN	HOSPITAL SARARE		
				FECHA	LOCALIZACIÓN	Dimensiones			No. Elementos	Medida Total
						LONG	ANCHO	ALTO		
						157,00			1,00	157,00
<b>SUB-TOTAL EJECUTADO</b>									<b>157,00</b>	
OBSERVACIONES:										
 Julian Camacho Reyes Ing. Civil Usta Tunja Tels: 300-7019971										

## MEMORIA DE CÁLCULO

OBJETO DEL PROYECTO



"CONSTRUCCION UCI DEL HOSPITAL SARARE DEL MUNICIPIO DE SARAVENA DEL DEPARTAMENTO DE ARAUCA"

CAPÍTULO	7.3	7.03.05	ITEM	UNION FLEX. 3 RANURADA	UNID.	UND	UBICACIÓN	HOSPITAL SARARE				
				FECHA	LOCALIZACIÓN	Dimensiones			No. Elemtnos	Medida Total		
						LONG	ANCHO	ALTO				
									12,00	12,00		
				<b>SUB-TOTAL EJECUTADO</b>								



OBSERVACIONES:

  
 Julian Camacho Reyes  
 Ing. Civil Usta Tunja Teli  
 300-7019971



## MEMORIA DE CÁLCULO

OBJETO DEL PROYECTO		<b>"CONSTRUCCION UCI DEL HOSPITAL SARARE DEL MUNICIPIO DE SARAVENA DEL DEPARTAMENTO DE ARAUCA"</b>												
CAPÍTULO	7.3	7.03.06	ITEM	ESCUDO P/ ROCIADOR BLANCO	UNID.	UND	UBICACIÓN	HOSPITAL SARARE						
				FECHA	LOCALIZACIÓN	Dimensiones			No. Elementos	Medida Total				
						LONG	ANCHO	ALTO						
										109,00	109,00			
<b>SUB-TOTAL EJECUTADO</b>										<b>109,00</b>				
OBSERVACIONES:														
 Julian Camacho Reyes Ing. Civil Usta Tunja Teli 300-7019971														



## MEMORIA DE CÁLCULO

OBJETO DEL PROYECTO		<b>"CONSTRUCCION UCI DEL HOSPITAL SARARE DEL MUNICIPIO DE SARAVENA DEL DEPARTAMENTO DE ARAUCA"</b>												
CAPÍTULO	7.3	7.03.07	ITEM	ROCIADOR 1/2 BR PEND RESP/RAPIDA 5.6 K	UNID.	UND	UBICACIÓN	HOSPITAL SARARE						
				FECHA	LOCALIZACIÓN	Dimensiones			No. Elementos	Medida Total				
							LONG	ANCHO	ALTO					
										109,00	109,00			
				<b>SUB-TOTAL EJECUTADO</b>						<b>109,00</b>				
OBSERVACIONES:														
 Julian Camacho Reyes Ing. Civil Usta Tunja Telf: 300-7019971														



## MEMORIA DE CÁLCULO

OBJETO DEL PROYECTO		<b>"CONSTRUCCION UCI DEL HOSPITAL SARARE DEL MUNICIPIO DE SARAVERA DEL DEPARTAMENTO DE ARAUCA"</b>												
CAPÍTULO	7.3	7.03.08	ITEM	RED BUSHING 1 X 1/2 H.O X 150	UNID.	UND	UBICACIÓN	HOSPITAL SARARE						
				FECHA	LOCALIZACIÓN	Dimensiones			No. Elemtnos	Medida Total				
						LONG	ANCHO	ALTO						
										100,00	100,00			
<b>SUB-TOTAL EJECUTADO</b>										<b>100,00</b>				
OBSERVACIONES:														
 Julian Camacho Reyes Ing. Civil Usta Tunja Tel: 300-7019971														

## MEMORIA DE CÁLCULO

OBJETO DEL PROYECTO		<b>"CONSTRUCCION UCI DEL HOSPITAL SARARE DEL MUNICIPIO DE SARAVENA DEL DEPARTAMENTO DE ARAUCA"</b>											
CAPÍTULO	7.3	7.03.09	ITEM	SIAMESA YEE 4 X 2 1/2 X 2 1/2 BR IMPOR INCLUYE INSTALACION	UNID.	UND	UBICACIÓN	HOSPITAL SARARE					
				FECHA	LOCALIZACIÓN	Dimensiones			No. Elementos	Medida Total			
							LONG	ANCHO	ALTO				
										1,00	1,00		
				<b>SUB-TOTAL EJECUTADO</b>						<b>1,00</b>			
<b>OBSERVACIONES:</b>													
 Julian Camacho Reyes Ing. Civil Usta Tunja Tels: 300-7019971													

## MEMORIA DE CÁLCULO

MEMORIA DE CÁLCULO													
OBJETO DEL PROYECTO		"CONSTRUCCION UCI DEL HOSPITAL SARARE DEL MUNICIPIO DE SARAVENA DEL DEPARTAMENTO DE ARAUCA"											
CAPÍTULO	7.3	7.03.10	ITEM	TEE 3 RANURADA		UNID.	UND	UBICACIÓN	HOSPITAL SARARE				
				FECHA	LOCALIZACIÓN	Dimensiones			No. Elemtnos	Medida Total			
						LONG	ANCHO	ALTO					
										2,00	2,00		
				<b>SUB-TOTAL EJECUTADO</b>						<b>2,00</b>			
OBSERVACIONES:													
 Julian Camacho Reyes Ing. Civil Usta Tunja Telli 300-7019971													



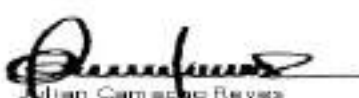

## MEMORIA DE CÁLCULO

OBJETO DEL PROYECTO		<b>"CONSTRUCCION UCI DEL HOSPITAL SARARE DEL MUNICIPIO DE SARAVENA DEL DEPARTAMENTO DE ARAUCA"</b>											
CAPÍTULO	7.3	7.03.11	ITEM	TEE 1 1/2 RANURADA	UNID.	ML	UBICACIÓN	HOSPITAL SARARE					
				FECHA	LOCALIZACIÓN	Dimensiones			No. Elemtnos	Medida Total			
						LONG	ANCHO	ALTO					
										52,00	52,00		
				<b>SUB-TOTAL EJECUTADO</b>						<b>52,00</b>			
OBSERVACIONES:													
 Julian Camacho Reyes Ing. Civil Usta Tunja Tels: 300-7019971													

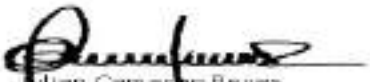

## MEMORIA DE CÁLCULO

OBJETO DEL PROYECTO		<b>"CONSTRUCCION UCI DEL HOSPITAL SARARE DEL MUNICIPIO DE SARAVENA DEL DEPARTAMENTO DE ARAUCA"</b>											
CAPÍTULO	7.3	7.03.12	ITEM	CHEQUE CORTINA 4 HD RAN ULFM FLOWCOM	UNID.	UND	UBICACIÓN	HOSPITAL SARARE					
				FECHA	LOCALIZACIÓN	Dimensiones			No. Elemtnos	Medida Total			
							LONG	ANCHO	ALTO				
										2,00	2,00		
				<b>SUB-TOTAL EJECUTADO</b>						<b>2,00</b>			
<b>OBSERVACIONES:</b>													
 Julian Camacho Reyes Ing. Civil Usta Tunja Tels: 300-7019971													

# MEMORIA DE CÁLCULO

OBJETO DEL PROYECTO		<b>"CONSTRUCCION UCI DEL HOSPITAL SARARE DEL MUNICIPIO DE SARAVENA DEL DEPARTAMENTO DE ARAUCA"</b>										
CAPÍTULO	7.3	7.03.13	ITEM	TUBO 4 PVC C-900 DR18	UNID.	ML	UBICACIÓN	HOSPITAL SARARE				
				FECHA	LOCALIZACIÓN	Dimensiones			No. Elementos	Medida Total		
						LONG	ANCHO	ALTO				
						33,57			1,00	33,57		
								<b>SUB-TOTAL EJECUTADO</b>				
OBSERVACIONES:												
 Julian Camacho Reyes Ing. Civil Usta Tunja Teli 300-7019971												

## MEMORIA DE CÁLCULO

MEMORIA DE CÁLCULO														
OBJETO DEL PROYECTO		"CONSTRUCCION UCI DEL HOSPITAL SARARE DEL MUNICIPIO DE SARAVENA DEL DEPARTAMENTO DE ARAUCA"												
CAPÍTULO	7.3	7.03.14	ITEM	VENTOSA 1 HD ULFM			UNID.	UND	UBICACIÓN	HOSPITAL SARARE				
				FECHA	LOCALIZACIÓN	Dimensiones			No. Elementos	Medida Total				
							LONG	ANCHO	ALTO					
										3,00	3,00			
<b>SUB-TOTAL EJECUTADO</b>										<b>3,00</b>				
OBSERVACIONES:														
 Jhian Camacho Reyes Ing. Civil Usta Tunja Tels: 300-7019971														

## MEMORIA DE CÁLCULO

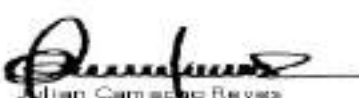
OBJETO DEL PROYECTO		<b>"CONSTRUCCION UCI DEL HOSPITAL SARARE DEL MUNICIPIO DE SARAVENA DEL DEPARTAMENTO DE ARAUCA"</b>												
CAPÍTULO	7.3	7.03.15	ITEM	SERIE 1100C RESTRAINERS FOR C-900 4	UNID.	UND	UBICACIÓN	HOSPITAL SARARE						
				FECHA	LOCALIZACIÓN	Dimensiones			No. Elementos	Medida Total				
							LONG	ANCHO	ALTO					
										4,00	4,00			
				<b>SUB-TOTAL EJECUTADO</b>						<b>4,00</b>				
OBSERVACIONES:														
 Julian Camacho Reyes Ing. Civil Usta Tunja Tels: 300-7019971														

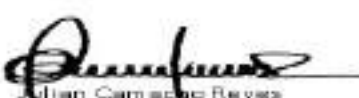

## MEMORIA DE CÁLCULO

OBJETO DEL PROYECTO													
"CONSTRUCCION UCI DEL HOSPITAL SARARE DEL MUNICIPIO DE SARAVENA DEL DEPARTAMENTO DE ARAUCA"													
CAPÍTULO	7.3	7.03.16	ITEM	ADAPT. FLANCHE 4 RANURADO	UNID.	UND	UBICACIÓN	HOSPITAL SARARE					
					FECHA	LOCALIZACIÓN	Dimensiones			No. Elemtnos	Medida Total		
							LONG	ANCHO	ALTO	3,00	3,00		
					<b>SUB-TOTAL EJECUTADO</b>								<b>3,00</b>
OBSERVACIONES:													
 Julian Camacho Reyes Ing. Civil Usta Tunja Teli 300-7019971													

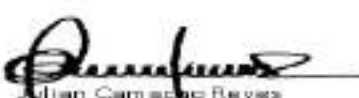
## MEMORIA DE CÁLCULO

OBJETO DEL PROYECTO		<b>"CONSTRUCCION UCI DEL HOSPITAL SARARE DEL MUNICIPIO DE SARAVENA DEL DEPARTAMENTO DE ARAUCA"</b>												
CAPÍTULO	7.3	7.03.17	ITEM	FLANCHE 4 RANURADO	UNID.	UND	UBICACIÓN	HOSPITAL SARARE						
				FECHA	LOCALIZACIÓN	Dimensiones			No. Elemtnos	Medida Total				
						LONG	ANCHO	ALTO						
										3,00	3,00			
				<b>SUB-TOTAL EJECUTADO</b>						<b>3,00</b>				
OBSERVACIONES:														
 Julian Camacho Reyes Ing. Civil Usta Tunja Teli 300-7019971														

## MEMORIA DE CÁLCULO

OBJETO DEL PROYECTO														
"CONSTRUCCION UCI DEL HOSPITAL SARARE DEL MUNICIPIO DE SARAVENA DEL DEPARTAMENTO DE ARAUCA"														
CAPÍTULO	7.3	7.03.18	ITEM	CODO 1 H.O X 150	UNID.	UND	UBICACIÓN	HOSPITAL SARARE						
					FECHA	LOCALIZACIÓN	Dimensiones			No. Elemtnos	Medida Total			
							LONG	ANCHO	ALTO	120,00	120,00			
					<b>SUB-TOTAL EJECUTADO</b>									<b>120,00</b>
OBSERVACIONES:														
 Julian Camacho Reyes Ing. Civil Usta Tunja Tels: 300-7019971														

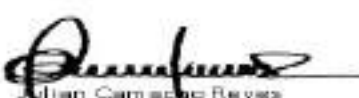

## MEMORIA DE CÁLCULO

OBJETO DEL PROYECTO		<b>"CONSTRUCCION UCI DEL HOSPITAL SARARE DEL MUNICIPIO DE SARAVENA DEL DEPARTAMENTO DE ARAUCA"</b>											
CAPÍTULO	7.3	7.03.19	ITEM	GABINETE CONTRA INCENDIO T3 DER SOBREPONE	UNID.		UND		UBICACIÓN	HOSPITAL SARARE			
				FECHA	LOCALIZACIÓN	Dimensiones			No. Elementos	Medida Total			
						LONG	ANCHO	ALTO					
										2,00	2,00		
<b>SUB-TOTAL EJECUTADO</b>										<b>2,00</b>			
OBSERVACIONES:													
 Julian Camacho Reyes Ing. Civil Usta Tunja Tels: 300-7019971													

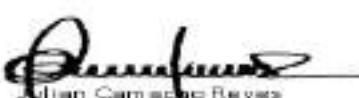

## MEMORIA DE CÁLCULO

OBJETO DEL PROYECTO														
"CONSTRUCCION UCI DEL HOSPITAL SARARE DEL MUNICIPIO DE SARAVENA DEL DEPARTAMENTO DE ARAUCA"														
CAPÍTULO	7.3	7.03.20	ITEM	CODO 3 RANURADO	UNID.	UND	UBICACIÓN	HOSPITAL SARARE						
					FECHA	LOCALIZACIÓN	Dimensiones			No. Elemtnos	Medida Total			
							LONG	ANCHO	ALTO	2,00	2,00			
					<b>SUB-TOTAL EJECUTADO</b>									<b>2,00</b>
OBSERVACIONES:														
 Julian Camacho Reyes Ing. Civil Usta Tunja Tels: 300-7019971														

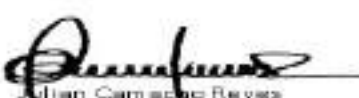
## MEMORIA DE CÁLCULO

OBJETO DEL PROYECTO		<b>"CONSTRUCCION UCI DEL HOSPITAL SARARE DEL MUNICIPIO DE SARAVENA DEL DEPARTAMENTO DE ARAUCA"</b>									
CAPÍTULO	7.3	7.03.21	ITEM	SOPORTE ANTISISMICO LATERAL 3 VIAS	UNID.	UND	UBICACIÓN	HOSPITAL SARARE			
				FECHA	LOCALIZACIÓN	Dimensiones			No. Elemtnos	Medida Total	
							LONG	ANCHO	ALTO		
										4,00	4,00
				<b>SUB-TOTAL EJECUTADO</b>						<b>4,00</b>	
OBSERVACIONES:											
 Julian Camacho Reyes Ing. Civil Usto Tunja Teli 300-7019971											



## MEMORIA DE CÁLCULO

OBJETO DEL PROYECTO		<b>"CONSTRUCCION UCI DEL HOSPITAL SARARE DEL MUNICIPIO DE SARAVENA DEL DEPARTAMENTO DE ARAUCA"</b>											
CAPÍTULO	7.3	7.03.22	ITEM	SOPORTE ANTISISMICO LONGIT 2 VIAS	UNID.	UND	UBICACIÓN	HOSPITAL SARARE					
				FECHA	LOCALIZACIÓN	Dimensiones			No. Elemtnos	Medida Total			
							LONG	ANCHO	ALTO				
										6,00	6,00		
				<b>SUB-TOTAL EJECUTADO</b>						<b>6,00</b>			
OBSERVACIONES:													
 Julian Camacho Reyes Ing. Civil Usto Tunja Teli 300-7019971													

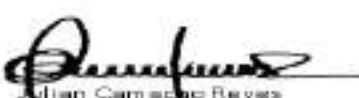

## MEMORIA DE CÁLCULO

MEMORIA DE CÁLCULO													
OBJETO DEL PROYECTO		"CONSTRUCCION UCI DEL HOSPITAL SARARE DEL MUNICIPIO DE SARAVENA DEL DEPARTAMENTO DE ARAUCA"											
CAPÍTULO	7.3	7.03.23	ITEM	ABRAZADERA TIPO PERA 3 ULFM	UNID.		UND		UBICACIÓN	HOSPITAL SARARE			
				FECHA	LOCALIZACIÓN	Dimensiones			No. Elementos	Medida Total			
						LONG	ANCHO	ALTO					
										50,00	50,00		
				<b>SUB-TOTAL EJECUTADO</b>									
OBSERVACIONES:													
 Julian Camacho Reyes Ing. Civil Usto Tunja Teli 300-7019971													

## MEMORIA DE CÁLCULO

OBJETO DEL PROYECTO		<b>"CONSTRUCCION UCI DEL HOSPITAL SARARE DEL MUNICIPIO DE SARAVENA DEL DEPARTAMENTO DE ARAUCA"</b>												
CAPÍTULO	7.3	7.03.24	ITEM	ABRAZADERA TIPO PERA 1 1/2 ULFM	UNID.	UND	UBICACIÓN	HOSPITAL SARARE						
				FECHA	LOCALIZACIÓN	Dimensiones			No. Elementos	Medida Total				
							LONG	ANCHO	ALTO					
										50,00	50,00			
				<b>SUB-TOTAL EJECUTADO</b>						<b>50,00</b>				
OBSERVACIONES:														
 Julian Camacho Reyes Ing. Civil Usta Tunja Tels: 300-7019971														

## MEMORIA DE CÁLCULO

OBJETO DEL PROYECTO		<b>"CONSTRUCCION UCI DEL HOSPITAL SARARE DEL MUNICIPIO DE SARAVENA DEL DEPARTAMENTO DE ARAUCA"</b>											
CAPÍTULO	7.3	7.03.25	ITEM	ABRAZADERA TIPO PERA 1 ULFM	UNID.	UND	UBICACIÓN	HOSPITAL SARARE					
				FECHA	LOCALIZACIÓN	Dimensiones			No. Elemtnos	Medida Total			
						LONG	ANCHO	ALTO					
										83,00	83,00		
				<b>SUB-TOTAL EJECUTADO</b>						<b>83,00</b>			
OBSERVACIONES:													
 Julian Camacho Reyes Ing. Civil Usta Tunja Teli 300-7019971													

## MEMORIA DE CÁLCULO

OBJETO DEL PROYECTO "CONSTRUCCION UCI DEL HOSPITAL SARARE DEL MUNICIPIO DE SARAVENA DEL DEPARTAMENTO DE ARAUCA"

CAPÍTULO	7.3	7.03.26	ITEM	ESTACION CONTROL, PRUEBA, DRENAJE 3"	UNID.	UND	UBICACIÓN	HOSPITAL SARARE					
				FECHA	LOCALIZACIÓN	Dimensiones			No. Elementos	Medida Total			
						LONG	ANCHO	ALTO					
										2,00	2,00		
				<b>SUB-TOTAL EJECUTADO</b>						<b>2,00</b>			

OBSERVACIONES:

  
 Julian Camacho Reyes  
 Ing. Civil Usta Tunja Tels:  
 300-7019971



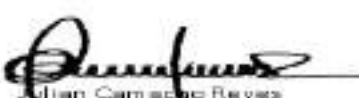

## MEMORIA DE CÁLCULO

OBJETO DEL PROYECTO		<b>"CONSTRUCCION UCI DEL HOSPITAL SARARE DEL MUNICIPIO DE SARAVENA DEL DEPARTAMENTO DE ARAUCA"</b>											
CAPÍTULO	7.3	7.03.27	ITEM	BASE PARA DETECTORES DE HUMO	UNID.	UND	UBICACIÓN	HOSPITAL SARARE					
				FECHA	LOCALIZACIÓN	Dimensiones			No. Elementos	Medida Total			
							LONG	ANCHO	ALTO				
										64,00	64,00		
				<b>SUB-TOTAL EJECUTADO</b>						<b>64,00</b>			
<b>OBSERVACIONES:</b>													
 Julian Camacho Reyes Ing. Civil Usta Tunja Tels: 300-7019971													

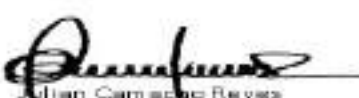
## MEMORIA DE CÁLCULO

OBJETO DEL PROYECTO													
"CONSTRUCCION UCI DEL HOSPITAL SARARE DEL MUNICIPIO DE SARAVENA DEL DEPARTAMENTO DE ARAUCA"													
CAPÍTULO	7.3	7.03.28	ITEM	DETECTORES DE HUMO	UNID.	UND	UBICACIÓN	HOSPITAL SARARE					
				FECHA	LOCALIZACIÓN	Dimensiones			No. Elemtnos	Medida Total			
						LONG	ANCHO	ALTO					
									64,00	64,00			
				<b>SUB-TOTAL EJECUTADO</b>									<b>64,00</b>
OBSERVACIONES:													
 Julian Camacho Reyes Ing. Civil Usta Tunja Teli 300-7019971													



## MEMORIA DE CÁLCULO

OBJETO DEL PROYECTO		<b>"CONSTRUCCION UCI DEL HOSPITAL SARARE DEL MUNICIPIO DE SARAVENA DEL DEPARTAMENTO DE ARAUCA"</b>												
CAPÍTULO	7.3	7.03.29	ITEM	CABLE FRLP ANTIFLAMA 2X18 AWG	UNID.	ML	UBICACIÓN	HOSPITAL SARARE						
				FECHA	LOCALIZACIÓN	Dimensiones			No. Elementos	Medida Total				
						LONG	ANCHO	ALTO						
						750,00				1,00	750,00			
<b>SUB-TOTAL EJECUTADO</b>										<b>750,00</b>				
OBSERVACIONES:														
 Julian Camacho Reyes Ing. Civil Usto Tunja Teli 300-7019971														

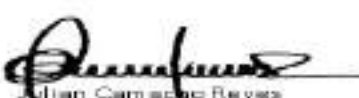
## MEMORIA DE CÁLCULO

OBJETO DEL PROYECTO		<b>"CONSTRUCCION UCI DEL HOSPITAL SARARE DEL MUNICIPIO DE SARAVENA DEL DEPARTAMENTO DE ARAUCA"</b>												
CAPÍTULO	7.3	7.03.30	ITEM	SIRENA CON EXTROBO LUZ ROJA	UNID.	UND	UBICACIÓN	HOSPITAL SARARE						
				FECHA	LOCALIZACIÓN	Dimensiones			No. Elemtnos	Medida Total				
						LONG	ANCHO	ALTO						
										16,00	16,00			
				<b>SUB-TOTAL EJECUTADO</b>										<b>16,00</b>
OBSERVACIONES:														
 Julian Camacho Reyes Ing. Civil Usta Tunja Teli 300-7019971														



## MEMORIA DE CÁLCULO

OBJETO DEL PROYECTO		<b>"CONSTRUCCION UCI DEL HOSPITAL SARARE DEL MUNICIPIO DE SARAVENA DEL DEPARTAMENTO DE ARAUCA"</b>											
CAPÍTULO	7.3	7.03.31	ITEM	ESTACION MANUAL DIRECCIONALBLE	UNID.	UND	UBICACIÓN	HOSPITAL SARARE					
				FECHA	LOCALIZACIÓN	Dimensiones			No. Elemtnos	Medida Total			
						LONG	ANCHO	ALTO					
										14,00	14,00		
				<b>SUB-TOTAL EJECUTADO</b>						<b>14,00</b>			
OBSERVACIONES:													
 Julian Camacho Reyes Ing. Civil Usta Tunja Teli 300-7019971													

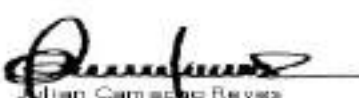

## MEMORIA DE CÁLCULO

OBJETO DEL PROYECTO		<b>"CONSTRUCCION UCI DEL HOSPITAL SARARE DEL MUNICIPIO DE SARAVENA DEL DEPARTAMENTO DE ARAUCA"</b>												
CAPÍTULO	7.3	7.03.32	ITEM	TUBERIA EMT DE 1/2"	UNID.	ML	UBICACIÓN	HOSPITAL SARARE						
				FECHA	LOCALIZACIÓN	Dimensiones			No. Elementos	Medida Total				
							LONG	ANCHO	ALTO					
						240,00				1,00	240,00			
				<b>SUB-TOTAL EJECUTADO</b>						<b>240,00</b>				
<b>OBSERVACIONES:</b>														
 Julian Camacho Reyes Ing. Civil Usta Tunja Tels: 300-7019971														

## MEMORIA DE CÁLCULO

OBJETO DEL PROYECTO		<b>"CONSTRUCCION UCI DEL HOSPITAL SARARE DEL MUNICIPIO DE SARAVENA DEL DEPARTAMENTO DE ARAUCA"</b>									
CAPÍTULO	7.3	7.03.33	ITEM	CAJAS RADWEL DE 10X10X7CM	UNID.	UND	UBICACIÓN	HOSPITAL SARARE			
				FECHA	LOCALIZACIÓN	Dimensiones			No. Elemtnos	Medida Total	
							LONG	ANCHO	ALTO		
										80,00	80,00
				<b>SUB-TOTAL EJECUTADO</b>						<b>80,00</b>	
OBSERVACIONES:											
 Julian Camacho Reyes Ing. Civil Usta Tunja Teli 300-7019971											

## MEMORIA DE CÁLCULO



OBJETO DEL PROYECTO		<b>"CONSTRUCCION UCI DEL HOSPITAL SARARE DEL MUNICIPIO DE SARAVENA DEL DEPARTAMENTO DE ARAUCA"</b>												
CAPÍTULO	7.3	7.03.34	ITEM	TERMINAL PARA TUBO EMT DE 1/2"	UNID.	UND	UBICACIÓN	HOSPITAL SARARE						
				FECHA	LOCALIZACIÓN	Dimensiones			No. Elemtnos	Medida Total				
						LONG	ANCHO	ALTO						
										240,00	240,00			
<b>SUB-TOTAL EJECUTADO</b>										<b>240,00</b>				
OBSERVACIONES:														
 Julian Camacho Reyes Ing. Civil Usta Tunja Tels: 300-7019971														



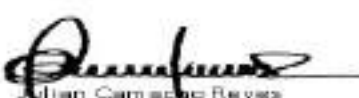

## MEMORIA DE CÁLCULO

OBJETO DEL PROYECTO		"CONSTRUCCION UCI DEL HOSPITAL SARARE DEL MUNICIPIO DE SARAVENA DEL DEPARTAMENTO DE ARAUCA"												
CAPÍTULO	7.3		7.03.35	ITEM	ADAPTADOR FLANCHE 4 RANURADO	UNID.	UND	UBICACIÓN	HOSPITAL SARARE					
					FECHA	LOCALIZACIÓN	Dimensiones			No. Elementos	Medida Total			
							LONG	ANCHO	ALTO					
										3,00	3,00			
<b>SUB-TOTAL EJECUTADO</b>										<b>3,00</b>				
OBSERVACIONES:														
 Julian Camacho Reyes Ing. Civil Usta Tunja Tels: 300-7019971														

## MEMORIA DE CÁLCULO

OBJETO DEL PROYECTO													
"CONSTRUCCION UCI DEL HOSPITAL SARARE DEL MUNICIPIO DE SARAVENA DEL DEPARTAMENTO DE ARAUCA"													
CAPÍTULO	7.3	7.03.36	ITEM	EMPAQUE NEOPRENO DE 4"	UNID.	UND	UBICACIÓN	HOSPITAL SARARE					
					FECHA	LOCALIZACIÓN	Dimensiones			No. Elementos	Medida Total		
							LONG	ANCHO	ALTO				
										1,00	1,00		
										<b>SUB-TOTAL EJECUTADO</b>			
OBSERVACIONES:													
 Julian Camacho Reyes Ing. Civil Usta Tunja Tels: 300-7019971													



## MEMORIA DE CÁLCULO

OBJETO DEL PROYECTO		<b>"CONSTRUCCION UCI DEL HOSPITAL SARARE DEL MUNICIPIO DE SARAVENA DEL DEPARTAMENTO DE ARAUCA"</b>												
CAPÍTULO	7.3	7.03.37	ITEM	PANEL DIRECCIONABLE.AUTOPROGLAMABLE.	UNID.	UND	UBICACIÓN	HOSPITAL SARARE						
				FECHA	LOCALIZACIÓN	Dimensiones			No. Elemtnos	Medida Total				
						LONG	ANCHO	ALTO						
										1,00	1,00			
<b>SUB-TOTAL EJECUTADO</b>										<b>1,00</b>				
<b>OBSERVACIONES:</b>														
 Julian Camacho Reyes Ing. Civil Usta Tunja Telf: 300-7019971														

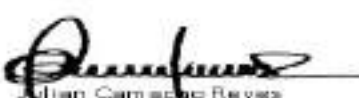

## MEMORIA DE CÁLCULO

OBJETO DEL PROYECTO		<b>"CONSTRUCCION UCI DEL HOSPITAL SARARE DEL MUNICIPIO DE SARAVENA DEL DEPARTAMENTO DE ARAUCA"</b>												
CAPÍTULO	7.3	7.03.38	ITEM	4000 STRAG MJ RESTRAJ FOR C-9000 4 PVC-PVC	UNID.	UND	UBICACIÓN	HOSPITAL SARARE						
				FECHA	LOCALIZACIÓN	Dimensiones			No. Elemtnos	Medida Total				
							LONG	ANCHO	ALTO					
										10,00	10,00			
<b>SUB-TOTAL EJECUTADO</b>										<b>10,00</b>				
<b>OBSERVACIONES:</b>														
 Julian Camacho Reyes Ing. Civil Usta Tunja Telf: 300-7019971														



## MEMORIA DE CÁLCULO

OBJETO DEL PROYECTO												
"CONSTRUCCION UCI DEL HOSPITAL SARARE DEL MUNICIPIO DE SARAVENA DEL DEPARTAMENTO DE ARAUCA"												
CAPÍTULO	7.3	7.03.39	ITEM	CANALIZACION DE PUNTOS	UNID.	UND	UBICACIÓN	HOSPITAL SARARE				
				FECHA	LOCALIZACIÓN	Dimensiones			No. Elementos	Medida Total		
						LONG	ANCHO	ALTO				
									30,00	30,00		
				<b>SUB-TOTAL EJECUTADO</b>								
OBSERVACIONES:												
 Julian Camacho Reyes Ing. Civil Usta Tunja Telf: 300-7019971												



## MEMORIA DE CÁLCULO

MEMORIA DE CÁLCULO														
OBJETO DEL PROYECTO		"CONSTRUCCION UCI DEL HOSPITAL SARARE DEL MUNICIPIO DE SARAVERA DEL DEPARTAMENTO DE ARAUCA"												
CAPÍTULO	7.4	7.04.01	ITEM	SUMINISTRO E INSTALACION DE DUCHA TELEFONO	UNID.	UND	UBICACIÓN	HOSPITAL SARARE						
				FECHA	LOCALIZACIÓN	Dimensiones			No. Elemtnos	Medida Total				
							LONG	ANCHO	ALTO					
										4,00	4,00			
<b>SUB-TOTAL EJECUTADO</b>										<b>4,00</b>				
OBSERVACIONES:														
 Julian Camacho Reyes Ing. Civil Usta Tunja Tel: 300-7019971														

## MEMORIA DE CÁLCULO



OBJETO DEL PROYECTO		<b>"CONSTRUCCION UCI DEL HOSPITAL SARARE DEL MUNICIPIO DE SARAVERENA DEL DEPARTAMENTO DE ARAUCA"</b>								
CAPÍTULO	7.4	7.04.02	ITEM	UNID.	UND	UBICACIÓN	HOSPITAL SARARE			
				SUMINISTRO E INSTALACION LAVAMANOS AVANTI CON PEDESTAL COLOR BLANCO INC. GRIFERIA						
				FECHA	LOCALIZACIÓN	Dimensiones			No. Elemtnos	Medida Total
						LONG	ANCHO	ALTO	9,00	9,00
<b>SUB-TOTAL EJECUTADO</b>							<b>9,00</b>			
<b>OBSERVACIONES:</b>										
 Julian Camacho Reyes Ing. Civil Usta Tunja Teli 300-7019971										

## MEMORIA DE CÁLCULO



OBJETO DEL PROYECTO		<b>"CONSTRUCCION UCI DEL HOSPITAL SARARE DEL MUNICIPIO DE SARAVERENA DEL DEPARTAMENTO DE ARAUCA"</b>											
CAPÍTULO	7.4	7.04.03	ITEM	SUMINISTRO E INSTALACION SANITARIO AVANTI PLUS BLANCO	UNID.	UND	UBICACIÓN	HOSPITAL SARARE					
				FECHA	LOCALIZACIÓN	Dimensiones			No. Elemtnos	Medida Total			
							LONG	ANCHO	ALTO				
										9,00	9,00		
				<b>SUB-TOTAL EJECUTADO</b>						<b>9,00</b>			
OBSERVACIONES:													
 Jhian Camacho Reyes Ing. Civil Usta Tunja Telli 300-7019971													



## MEMORIA DE CÁLCULO

MEMORIA DE CÁLCULO													
OBJETO DEL PROYECTO		"CONSTRUCCION UCI DEL HOSPITAL SARARE DEL MUNICIPIO DE SARAVENA DEL DEPARTAMENTO DE ARAUCA"											
CAPÍTULO	7.4	7.04.04	ITEM	LAVAMANOS EN ACERO INOXIDABLE DE PEDAL	UNID.	UND	UBICACIÓN	HOSPITAL SARARE					
				FECHA	LOCALIZACIÓN	Dimensiones			No. Elemtnos	Medida Total			
						LONG	ANCHO	ALTO					
										12,00	12,00		
				<b>SUB-TOTAL EJECUTADO</b>						<b>12,00</b>			
OBSERVACIONES:													
 Julian Camacho Reyes Ing. Civil Usta Tunja Teli 300-7019971													



## MEMORIA DE CÁLCULO

OBJETO DEL PROYECTO		<b>"CONSTRUCCION UCI DEL HOSPITAL SARARE DEL MUNICIPIO DE SARAVENA DEL DEPARTAMENTO DE ARAUCA"</b>											
CAPÍTULO	7.4	7.04.05	ITEM	LAVAPLATOS EN ACERO INOXIDABLE L=1.00 M.CON BANDEJA-INCLUYE INSTALACION	UNID.	UND	UBICACIÓN	HOSPITAL SARARE					
				FECHA	LOCALIZACIÓN	Dimensiones			No. Elemtnos	Medida Total			
							LONG	ANCHO	ALTO				
										7,00	7,00		
				<b>SUB-TOTAL EJECUTADO</b>						<b>7,00</b>			
<b>OBSERVACIONES:</b>													
 Julian Camacho Reyes Ing. Civil Usta Tunja Teli 300-7019971													

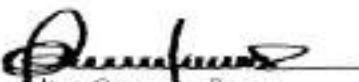

## MEMORIA DE CÁLCULO

OBJETO DEL PROYECTO		<b>"CONSTRUCCION UCI DEL HOSPITAL SARARE DEL MUNICIPIO DE SARAVERA DEL DEPARTAMENTO DE ARAUCA"</b>												
CAPÍTULO	7.4	7.04.06	ITEM	GRIFERIA TIPO GANZO INST	UNID.	UND	UBICACIÓN	HOSPITAL SARARE						
				FECHA	LOCALIZACIÓN	Dimensiones			No. Elemtnos	Medida Total				
						LONG	ANCHO	ALTO						
										9,00	9,00			
				<b>SUB-TOTAL EJECUTADO</b>						<b>9,00</b>				
OBSERVACIONES:														
 Julian Camacho Reyes Ing. Civil Usta Tunja Teli: 300-7019971														

## MEMORIA DE CÁLCULO

OBJETO DEL PROYECTO		<b>"CONSTRUCCION UCI DEL HOSPITAL SARARE DEL MUNICIPIO DE SARAVENA DEL DEPARTAMENTO DE ARAUCA"</b>											
CAPÍTULO	7.4	7.04.07	ITEM	DUCHA CON LLAVE DE CORTE 1/2 PULG. ANTIVANDALICA	UNID.	UND	UBICACIÓN	HOSPITAL SARARE					
				FECHA	LOCALIZACIÓN	Dimensiones			No. Elemtnos	Medida Total			
						LONG	ANCHO	ALTO					
									2,00	2,00			
<b>SUB-TOTAL EJECUTADO</b>									<b>2,00</b>				
<b>OBSERVACIONES:</b>													
 Julian Camacho Reyes Ing. Civil Usta Tunja Teli 300-7019971													

## MEMORIA DE CÁLCULO

OBJETO DEL PROYECTO		<b>"CONSTRUCCION UCI DEL HOSPITAL SARARE DEL MUNICIPIO DE SARAVERA DEL DEPARTAMENTO DE ARAUCA"</b>												
CAPÍTULO	7.4	7.04.08	ITEM	GRIFERIA LAVAPLATOS FLAMINGO S/PARED 8"	UNID.	UND	UBICACIÓN	HOSPITAL SARARE						
				FECHA	LOCALIZACIÓN	Dimensiones			No. Elemtnos	Medida Total				
						LONG	ANCHO	ALTO						
										7,00	7,00			
				<b>SUB-TOTAL EJECUTADO</b>						<b>7,00</b>				
OBSERVACIONES:														
 Julian Camacho Reyes Ing. Civil Usta Tunja Tels: 300-7019971														

## MEMORIA DE CÁLCULO

OBJETO DEL PROYECTO "CONSTRUCCION UCI DEL HOSPITAL SARARE DEL MUNICIPIO DE SARAVERA DEL DEPARTAMENTO DE ARAUCA"

CAPÍTULO	7.4	7.04.09	ITEM	VALVULA DE PEDAL A.F	UNID.	UND	UBICACIÓN	HOSPITAL SARARE						
				FECHA	LOCALIZACIÓN	Dimensiones			No. Elemtnos	Medida Total				
						LONG	ANCHO	ALTO						
										12,00	12,00			
				<b>SUB-TOTAL EJECUTADO</b>										<b>12,00</b>

OBSERVACIONES:

  
 Julian Camacho Reyes  
 Ing. Civil Usta Tunja Tels:  
 300-7019971

## MEMORIA DE CÁLCULO

**OBJETO DEL PROYECTO** "CONSTRUCCION UCI DEL HOSPITAL SARARE DEL MUNICIPIO DE SARAVENA DEL DEPARTAMENTO DE ARAUCA"



<b>CAPÍTULO</b>	8.0	8.01	<b>ITEM</b>	MARCO Y VENTANA EN ALUMINIO ANONIZADO NATURAL SISTEMA BATIENTE BISAGRAS DE PIVOTE CRISTAL INCOLORO TEMPLADO 8MM HALADERA EN ACERO Y ZOCALO EN ACERO	<b>UNID.</b>	<b>M2</b>	<b>UBICACIÓN</b>	<b>HOSPITAL SARARE</b>
-----------------	-----	------	-------------	---	--------------	-----------	------------------	------------------------

	FECHA	LOCALIZACIÓN	Dimensiones			No. Elemtnos	Medida Total
			LONG	ANCHO	ALTO		
		V - 00	2,83		1,60	1,00	4,53
		V - 01	2,50		1,60	1,00	4,00
		V - 02	3,80		1,60	15,00	91,20
		V - 03	1,00		1,60	3,00	4,80
		V - 04	1,50		0,50	7,00	5,25
		V - 05	2,55		1,60	2,00	8,16
		V - 06	3,02		1,60	2,00	9,66
		V - 07	1,25		1,60	1,00	2,00
		V - 08	1,17		0,50	3,00	1,76
		V - 09	0,60		0,50	1,00	0,30
		V - 10	1,30		1,60	1,00	2,08
		V - 11	1,50		3,60	11,00	59,40
		V - 12	1,40		3,60	3,00	15,12
		V - 13	1,70		1,60	14,00	38,08
		V - 14	0,75		0,75	2,00	1,13
		V - 15	1,10		0,50	1,00	0,55
	V - 16	1,00		0,50	1,00	0,50	
<b>SUB-TOTAL EJECUTADO</b>							<b>248,51</b>

**OBSERVACIONES:**

  
 Julian Camacho Reyes  
 Ing: Civil Usta Tunja Tel:  
 300-7019971

## MEMORIA DE CÁLCULO

OBJETO DEL PROYECTO		"CONSTRUCCION UCI DEL HOSPITAL SARARE DEL MUNICIPIO DE SARAVENA DEL DEPARTAMENTO DE ARAUCA"											
CAPÍTULO	8.0	8.02	ITEM	BARANDAS EN ACERO INOXIDABLE PARA BAÑOS DE PMR	UNID.	ML	UBICACIÓN	HOSPITAL SARARE					
				FECHA	LOCALIZACIÓN	Dimensiones			No. Elemtnos	Medida Total			
				LONG	ANCHO	ALTO			1,00	20,00			
													
				<b>SUB-TOTAL EJECUTADO</b>									<b>20,00</b>
<b>OBSERVACIONES:</b>													
 Julian Camacho Reyes Ing: Civil Usta Tunja Tel: 300-7019971													

















## MEMORIA DE CÁLCULO

OBJETO DEL PROYECTO		"CONSTRUCCION UCI DEL HOSPITAL SARARE DEL MUNICIPIO DE SARAVERA DEL DEPARTAMENTO DE ARAUCA"								
CAPÍTULO	9.0	9.01	ITEM	PUERTA DE HOJA EN MADERA ENTAMBORADA + PINTURA DEFINIDA EN OBRA. CON CERRADURA DE MANIJA DURALOCK CROMADA MATE.Y ZOCALO EN LAMINA DE ACERO INOXIDABLE	UNID.	M2	UBICACIÓN	HOSPITAL SARARE		
				FECHA	LOCALIZACIÓN	Dimensiones			No. Elemtnos	Medida Total
						LONG	ANCHO	ALTO		
					P - 2	1,50		2,50	1,00	3,75
					P - 4	1,00		2,50	24,00	60,00
					P - 7	0,70		2,50	10,00	17,50
				<b>SUB-TOTAL EJECUTADO</b>						
OBSERVACIONES: VER PLANO ARQUITECTONICO AD-005-11 CUADRO DE PUERTAS										
 Julian Camacho Reyes Ing. Civil Usta Tunja Tel: 300-7019971										

## MEMORIA DE CÁLCULO

OBJETO DEL PROYECTO		"CONSTRUCCION UCI DEL HOSPITAL SARARE DEL MUNICIPIO DE SARAVERA DEL DEPARTAMENTO DE ARAUCA"								
CAPÍTULO	9.0	9.02	ITEM	UNID.	ML	UBICACIÓN	HOSPITAL SARARE			
				MUEBLE BAJO 0.80 M CEDRO CAQUETA (INCLUYE PUERTAS, ENTREPAÑOS, HERRAJES) Y DEMÁS ELEMENTOS PARA						
				FECHA	LOCALIZACIÓN	Dimensiones			No. Elemtnos	Medida Total
						LONG	ANCHO	ALTO		
				41,75			1,00	41,75		
<b>SUB-TOTAL EJECUTADO</b>							<b>41,75</b>			
<b>OBSERVACIONES:</b>										
 Julian Camacho Reyes Ing. Civil Usta Tunja Tel: 300-7019971										

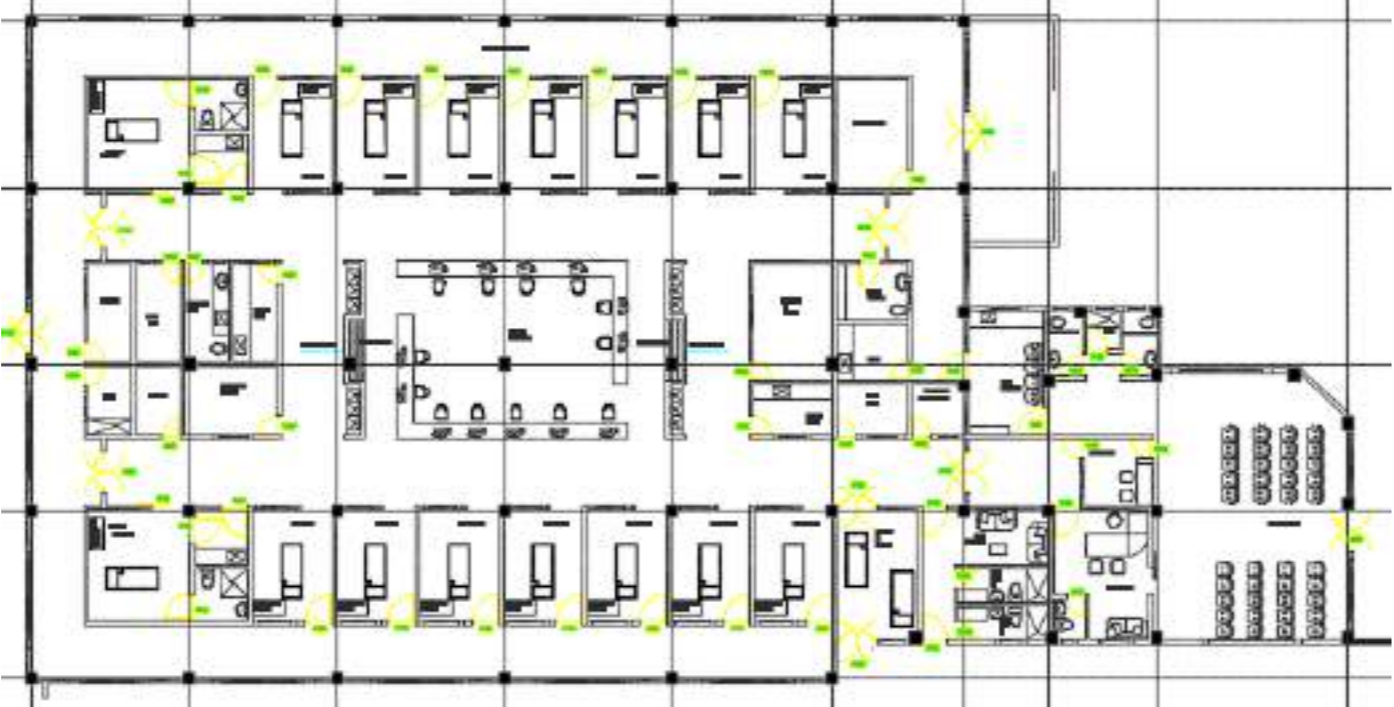
## MEMORIA DE CÁLCULO

OBJETO DEL PROYECTO		"CONSTRUCCION UCI DEL HOSPITAL SARARE DEL MUNICIPIO DE SARAVENA DEL DEPARTAMENTO DE ARAUCA"								
CAPÍTULO	9.0	9.03	ITEM	UNID.	M2	UBICACIÓN	HOSPITAL SARARE			
				MUBLES MADERA PINO (INCLUYE PUERTAS, ENTREPAÑOS, HERRAJES) Y DEMÁS ELEMENTOS PARA SU BUEN						
				FECHA	LOCALIZACIÓN	Dimensiones			No. Elemtnos	Medida Total
				LONG	ANCHO	ALTO				
				4,30			1,00	4,30		
<b>SUB-TOTAL EJECUTADO</b>							<b>4,30</b>			
<b>OBSERVACIONES:</b>										
 Julian Camacho Reyes Ing: Civil Usta Tunja Tel: 300-7019971										











## MEMORIA DE CÁLCULO

**OBJETO DEL PROYECTO** "CONSTRUCCION UCI DEL HOSPITAL SARARE DEL MUNICIPIO DE SARAVENA DEL DEPARTAMENTO DE ARAUCA"

<b>CAPÍTULO</b>	9	9.08	<b>ITEM NUEVO</b>	MUEBLE REF 02 DE 2,80*1,10*,60 MTS PARA FILTRO DE VISITANTES	UNID.	UND	UBICACIÓN	HOSPITAL SARARE
-----------------	---	------	-------------------	--	-------	-----	-----------	-----------------

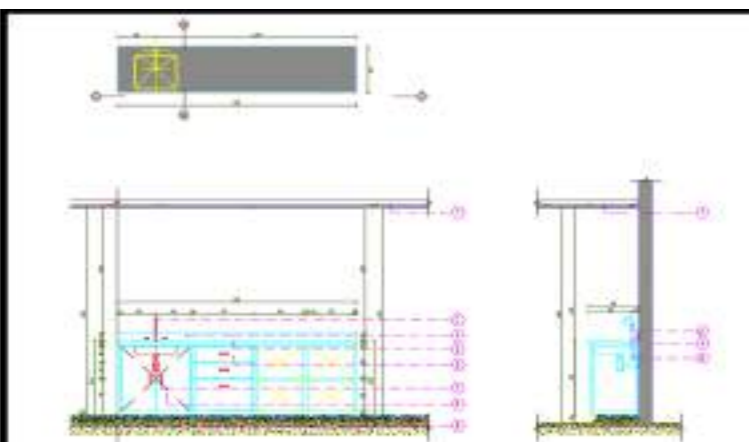
ESQUEMA DE MUEBLE	CODIGO Y TIPO DE MUEBLE	CANTIDAD	FECHA	LOCALIZACIÓN	Dimensiones			No. Elemtnos	Medida Total		
					LONG	ANCHO	ALTO				
	M-02	1									
				M-02		2,80	0,60	1,10	1,00	1,00	
			<b>SUB-TOTAL EJECUTADO</b>								<b>1,00</b>

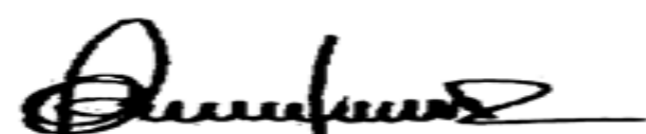

**OBSERVACIONES:** Ver Plano Arquitectonico Cuadro de Muebles AD 10 -11 y AD 11-11

  
 Julian Camacho Reyes  
 Ing. Civil Usta Tunja Tel:  
 300-7019971



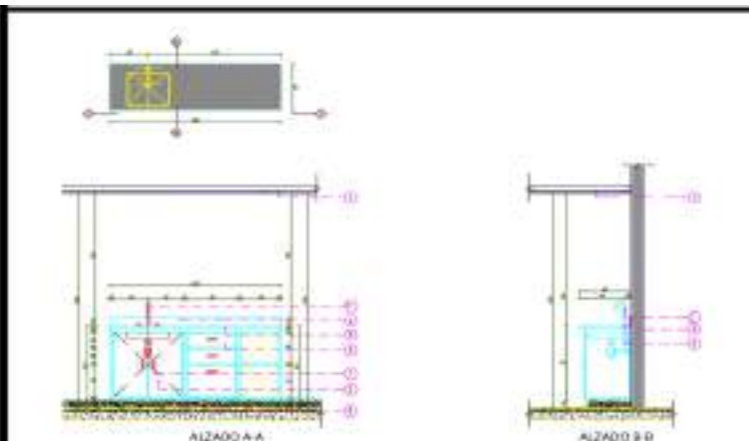
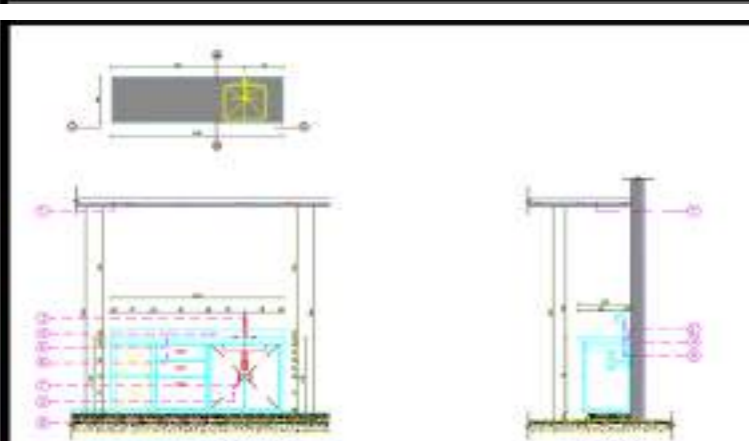

## MEMORIA DE CÁLCULO

OBJETO DEL PROYECTO		"CONSTRUCCION UCI DEL HOSPITAL SARARE DEL MUNICIPIO DE SARAVERA DEL DEPARTAMENTO DE ARAUCA"									
CAPÍTULO	9	9.11	ITEM NUEVO	MUEBLE REF 05-08 DE 2,0*1,10*,60 MTS PARA CUBÍCULO AISLADO	UNID.	UND	UBICACIÓN	HOSPITAL SARARE			
				FECHA	LOCALIZACIÓN	Dimensiones			No. Elemtnos	Medida Total	
				LONG	ANCHO	ALTO					
ESQUEMA DE MUEBLE				CODIGO Y TIPO DE MUEBLE	CANTIDAD						
				<b>M-05</b>	<b>1</b>						
				<b>M-08</b>	<b>1</b>						
						<b>SUB-TOTAL EJECUTADO</b>			<b>2,00</b>		
OBSERVACIONES: Ver Plano Arquitectonico Cuadro de Muebles AD 10 -11 y AD 11-11											
 Julian Camacho Reyes Ing. Civil Usta Tunja Tel: 300-7019971											

## MEMORIA DE CÁLCULO

**OBJETO DEL PROYECTO** "CONSTRUCCION UCI DEL HOSPITAL SARARE DEL MUNICIPIO DE SARAVENA DEL DEPARTAMENTO DE ARAUCA"

<b>CAPÍTULO</b>	9	9.12	ITEM NUEVO	MUEBLE REF 06 DE 3,5*1,10*,60 MTS PARA TRABAJO SUCIO	UNID.	UND	UBICACIÓN	HOSPITAL SARARE
-----------------	---	------	------------	--	-------	-----	-----------	-----------------

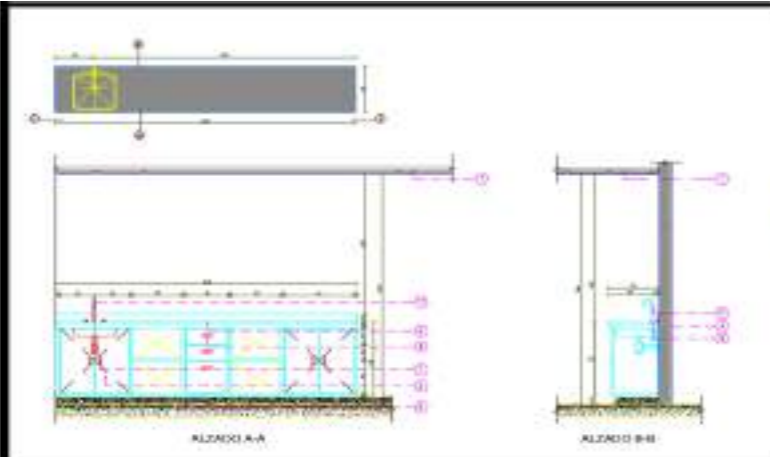
ESQUEMA DE MUEBLE	CODIGO Y TIPO DE MUEBLE	CANTIDAD	FECHA	LOCALIZACIÓN	Dimensiones			No. Elemtnos	Medida Total		
					LONG	ANCHO	ALTO				
	M-06	1									
				M 06	3,50	0,60	1,10	1,00	1,00		
			<b>SUB-TOTAL EJECUTADO</b>								<b>1,00</b>

**OBSERVACIONES:** Ver Plano Arquitectonico Cuadro de Muebles AD 10 -11 y AD 11-11

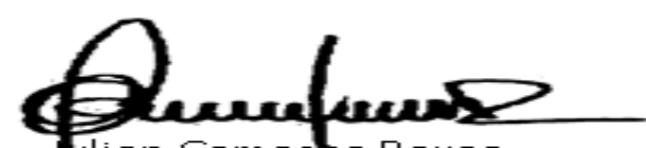
  
 Julian Camacho Reyes  
 Ing. Civil Usta Tunja Tel:  
 300-7019971



## MEMORIA DE CÁLCULO

<b>OBJETO DEL PROYECTO</b>	<b>"CONSTRUCCION UCI DEL HOSPITAL SARARE DEL MUNICIPIO DE SARAVENA DEL DEPARTAMENTO DE ARAUCA"</b>						
----------------------------	--	--	--	--	--	--	--

<b>CAPÍTULO</b>	9	9.13	<b>ITEM NUEVO</b>	MUEBLE REF 07 DE 2,5*1,10*,60 MTS PARA LAVADO DE PLATOS	UNID.	UND	UBICACIÓN	HOSPITAL SARARE
-----------------	---	------	-------------------	---	-------	-----	-----------	-----------------

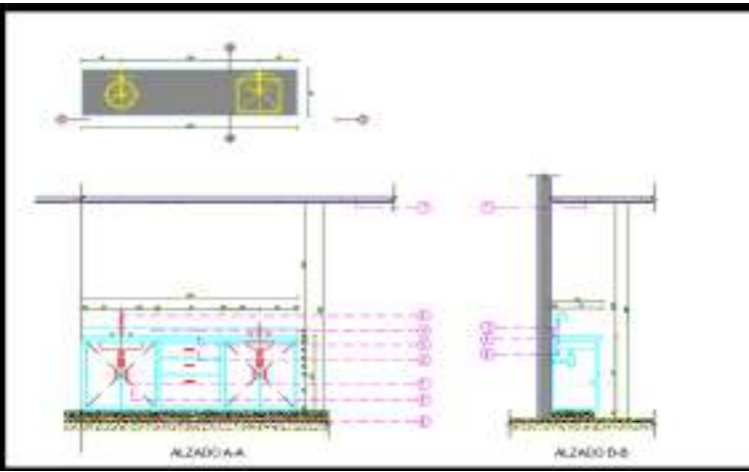
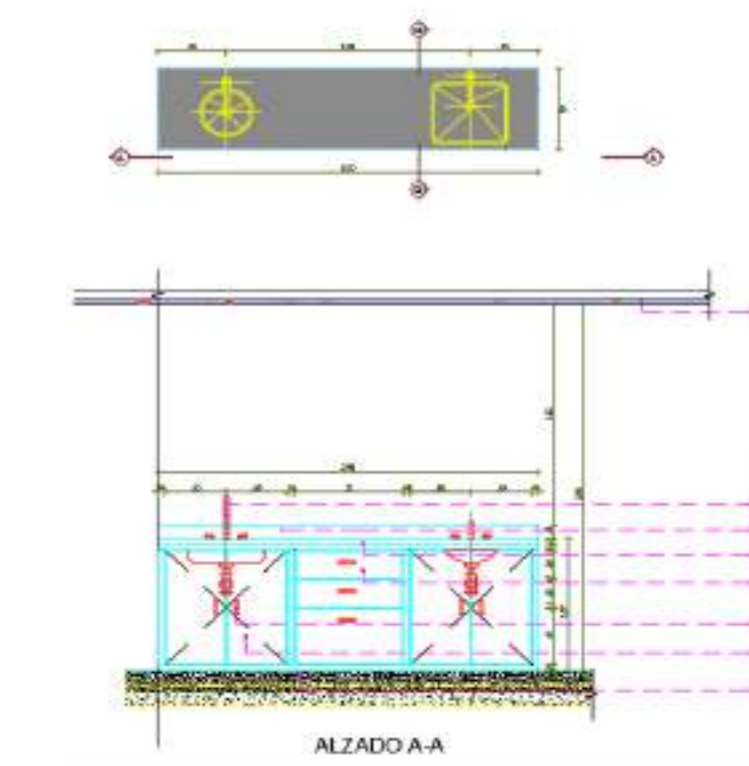
ESQUEMA DE MUEBLE	CODIGO Y TIPO DE MUEBLE	CANTIDAD	FECHA	LOCALIZACIÓN	Dimensiones			No. Elemtnos	Medida Total
					LONG	ANCHO	ALTO		
	M-07	1							
			M 07	2,50	0,60	1,10	1,00	1,00	
									
<b>SUB-TOTAL EJECUTADO</b>								<b>1,00</b>	

**OBSERVACIONES:** Ver Plano Arquitectonico Cuadro de Muebles AD 10 -11 y AD 11-11

  
 Julian Camacho Reyes  
 Ing. Civil Usta Tunja Tel:  
 300-7019971

## MEMORIA DE CÁLCULO

<b>OBJETO DEL PROYECTO</b>	<b>"CONSTRUCCION UCI DEL HOSPITAL SARARE DEL MUNICIPIO DE SARAVERA DEL DEPARTAMENTO DE ARAUCA"</b>						
----------------------------	--	--	--	--	--	--	--

<b>CAPÍTULO</b>	9	9.14	<b>ITEM NUEVO</b>	MUEBLE REF 09 DE 1,85*1,30*60 MTS PARA LAVADO QUIRURGICO	UNID.	UND	UBICACIÓN	HOSPITAL SARARE
-----------------	---	------	-------------------	--	-------	-----	-----------	-----------------

<b>ESQUEMA DE MUEBLE</b>	<b>CODIGO Y TIPO DE MUEBLE</b>	<b>CANTIDAD</b>	FECHA	LOCALIZACIÓN	Dimensiones			No. Elemtnos	Medida Total			
					LONG	ANCHO	ALTO					
<p style="text-align: center;">ALZADO A-A</p> <p style="text-align: center;">ALZADO B-B</p>	M 09	1,00			2,50	0,60	1,10	1,00	1,00			
			<b>SUB-TOTAL EJECUTADO</b>								<b>1,00</b>	

**OBSERVACIONES:** Ver Plano Arquitectonico Cuadro de Muebles AD 10 -11 y AD 11-11

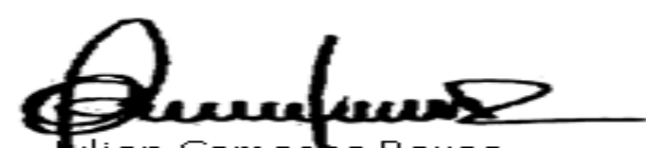
  
 Julian Camacho Reyes  
 Ing. Civil Usta Tunja Tel:  
 300-7019971

## MEMORIA DE CÁLCULO

**OBJETO DEL PROYECTO** "CONSTRUCCION UCI DEL HOSPITAL SARARE DEL MUNICIPIO DE SARAVENA DEL DEPARTAMENTO DE ARAUCA"

<b>CAPÍTULO</b>	9	9.15	<b>ITEM NUEVO</b>	MUEBLE REF 10 DE 25,16*1,10*,75 MTS PARA ESTACION DE ENFERMERIA	UNID.	UND	UBICACIÓN	HOSPITAL SARARE
-----------------	---	------	-------------------	---	-------	-----	-----------	-----------------

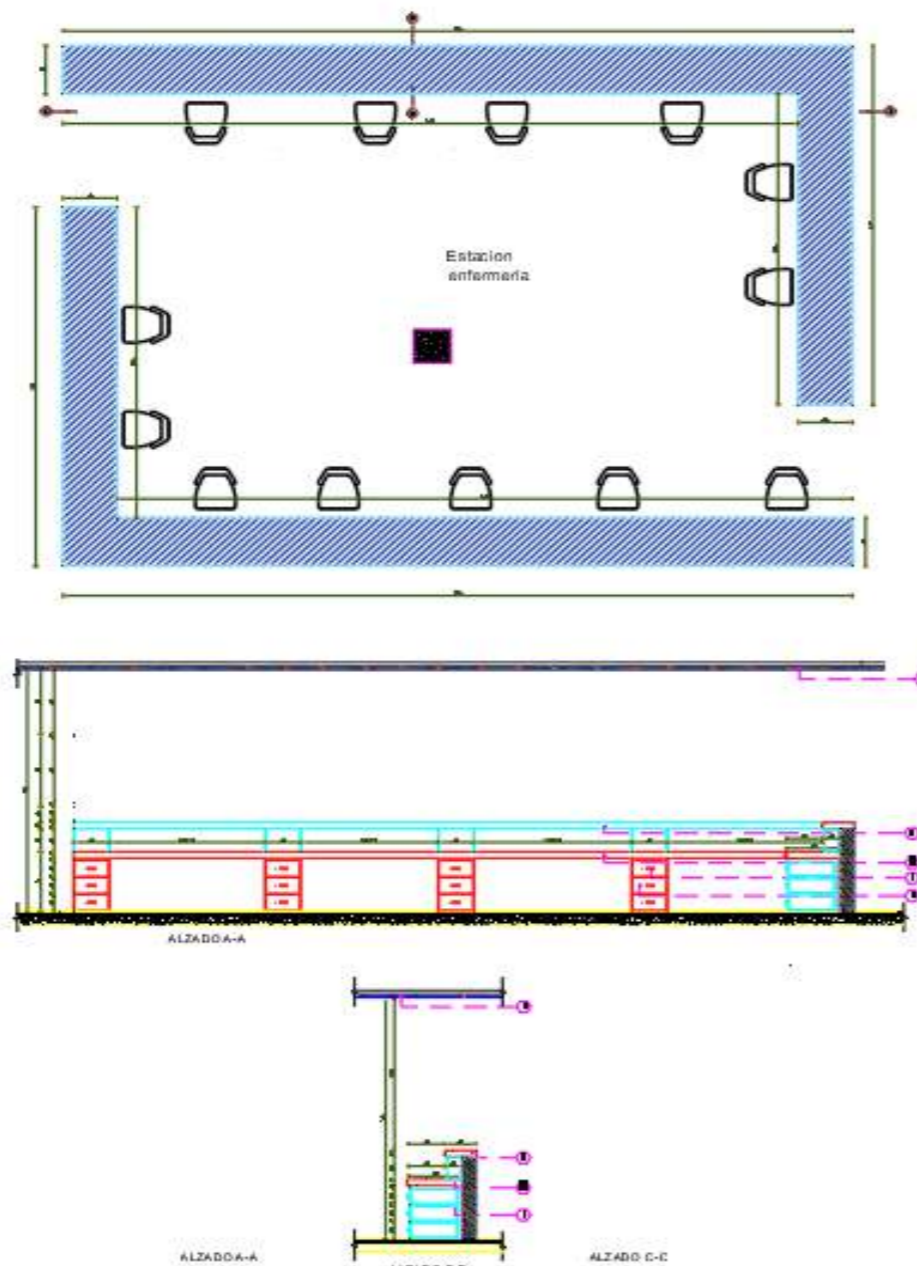
ESQUEMA DE MUEBLE	CODIGO Y TIPO DE MUEBLE	CANTIDAD	FECHA	LOCALIZACIÓN	Dimensiones			No. Elemtnos	Medida Total	
					LONG	ANCHO	ALTO			
										
					M 10	25,16	0,75	1,10	1,00	1,00
	<b>SUB-TOTAL EJECUTADO</b>									<b>1,00</b>

OBSERVACIONES: Ver Plano Arquitectonico Cuadro de Muebles AD 10 -11 y AD 11-11

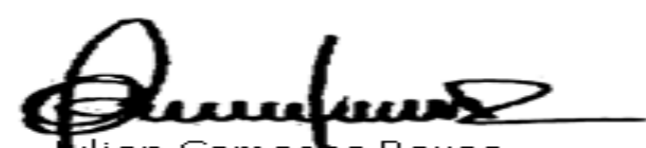
  
 Julian Camacho Reyes  
 Ing. Civil Usta Tunja Tel:  
 300-7019971