





MEMORIA DE CÁLCULO

OBJETO DEL PROYECTO		"CONSTRUCCION UCI DEL HOSPITAL SARARE DEL MUNICIPIO DE SARAVENA DEL DEPARTAMENTO DE ARAUCA"												
CAPÍTULO	11	11.01.01	ITEM	TUBERÍA COBRE TIPO L 1/2"	UNID.	ML	UBICACIÓN	HOSPITAL SARARE						
				FECHA	LOCALIZACIÓN	Dimensiones			No. Elementos	Medida Total				
							LONG	ANCHO	ALTO					
						471,00				1,00	471,00			
SUB-TOTAL EJECUTADO										471,00				
OBSERVACIONES:														
 Julian Camacho Reyes Ing. Civil Usta Tunja Tel: 300-7019971														

MEMORIA DE CÁLCULO

OBJETO DEL PROYECTO		"CONSTRUCCION UCI DEL HOSPITAL SARARE DEL MUNICIPIO DE SARAVENA DEL DEPARTAMENTO DE ARAUCA"											
CAPÍTULO	11	11.01.02	ITEM	TUBERÍA COBRE TIPO L 3/4"	UNID.	ML	UBICACIÓN	HOSPITAL SARARE					
				FECHA	LOCALIZACIÓN	Dimensiones			No. Elemtnos	Medida Total			
						LONG	ANCHO	ALTO					
						178,00			1,00	178,00			
				SUB-TOTAL EJECUTADO									178,00
				OBSERVACIONES:									
				 Julian Camacho Reyes Ing. Civil Usta Tunja Tel: 300-7019971									

MEMORIA DE CÁLCULO

OBJETO DEL PROYECTO		"CONSTRUCCION UCI DEL HOSPITAL SARARE DEL MUNICIPIO DE SARAVENA DEL DEPARTAMENTO DE ARAUCA"												
CAPÍTULO	11	11.01.03	ITEM	TUBERÍA COBRE TIPO L 1 1/4"	UNID.	ML	UBICACIÓN	HOSPITAL SARARE						
				FECHA	LOCALIZACIÓN	Dimensiones			No. Elementos	Medida Total				
							LONG	ANCHO	ALTO					
						89,00				1,00	89,00			
				SUB-TOTAL EJECUTADO										89,00
OBSERVACIONES:														
 Julian Camacho Reyes Ing. Civil Usta Tunja Tel: 300-7019971														

MEMORIA DE CÁLCULO

OBJETO DEL PROYECTO "CONSTRUCCION UCI DEL HOSPITAL SARARE DEL MUNICIPIO DE SARAVENA DEL DEPARTAMENTO DE ARAUCA"

CAPÍTULO	11	11.02.01	ITEM	3 GASES (OXI 3/4"-AIR 3/4"-VAC 1 1/4")	UNID.	UND	UBICACIÓN	HOSPITAL SARARE					
				FECHA	LOCALIZACIÓN	Dimensiones			No. Elemtnos	Medida Total			
						LONG	ANCHO	ALTO					
										1,00	1,00		
SUB-TOTAL EJECUTADO									1,00				

OBSERVACIONES:

 Julian Camacho Reyes
 Ing. Civil Usta Tunja Tel:
 300-7019971

MEMORIA DE CÁLCULO

OBJETO DEL PROYECTO "CONSTRUCCION UCI DEL HOSPITAL SARARE DEL MUNICIPIO DE SARAVENA DEL DEPARTAMENTO DE ARAUCA"

CAPÍTULO	11	11.03.01	ITEM	1/2" (TIPO SENSOR ACERO INOX)	UNID.	UND	UBICACIÓN	HOSPITAL SARARE					
				FECHA	LOCALIZACIÓN	Dimensiones			No. Elemtnos	Medida Total			
						LONG	ANCHO	ALTO					
										3,00	3,00		
				SUB-TOTAL EJECUTADO									3,00

OBSERVACIONES:



 Julian Camacho Reyes
 Ing. Civil Usta Tunja Tel:
 300-7019971

MEMORIA DE CÁLCULO

OBJETO DEL PROYECTO		"CONSTRUCCION UCI DEL HOSPITAL SARARE DEL MUNICIPIO DE SARAVENA DEL DEPARTAMENTO DE ARAUCA"												
CAPÍTULO	11	11.03.02	ITEM	VALVULA DE BOLA EN ACERO INOX. DE 1/2"	UNID.	UND	UBICACIÓN	HOSPITAL SARARE						
				FECHA	LOCALIZACIÓN	Dimensiones			No. Elemtnos	Medida Total				
							LONG	ANCHO	ALTO					
										70,00	70,00			
				SUB-TOTAL EJECUTADO						70,00				
OBSERVACIONES:														
 Jilian Camacho Reyes Ing. Civil Usta Funja Tel: 300-7019971														

MEMORIA DE CÁLCULO

OBJETO DEL PROYECTO: "CONSTRUCCION UCI DEL HOSPITAL SARARE DEL MUNICIPIO DE SARAVENA DEL DEPARTAMENTO DE ARAUCA"

CAPÍTULO	11	11.03.03	ITEM	VALVULA DE BOLA EN ACERO INOX. DE 3/4"	UNID.	UND	UBICACIÓN	HOSPITAL SARARE					
				FECHA	LOCALIZACIÓN	Dimensiones			No. Elemtnos	Medida Total			
						LONG	ANCHO	ALTO					
										37,00	37,00		
								SUB-TOTAL EJECUTADO					

OBSERVACIONES:

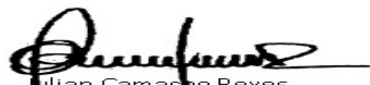

 Julian Camacho Reyes
 Ing. Civil Usta Tunja Tel:
 300-7019971

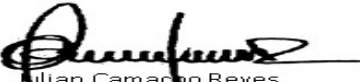
MEMORIA DE CÁLCULO

OBJETO DEL PROYECTO		"CONSTRUCCION UCI DEL HOSPITAL SARARE DEL MUNICIPIO DE SARAVENA DEL DEPARTAMENTO DE ARAUCA"												
CAPÍTULO	11	11.03.04	ITEM	VALVULA DE BOLA EN ACERO INOX. DE 1 1/4"	UNID.	UND	UBICACIÓN	HOSPITAL SARARE						
				FECHA	LOCALIZACIÓN	Dimensiones			No. Elementos	Medida Total				
						LONG	ANCHO	ALTO						
										1,00	1,00			
				SUB-TOTAL EJECUTADO										1,00
OBSERVACIONES:														
 Julian Camacho Reyes Ing. Civil Usta Tunja Tel: 300-7019971														

MEMORIA DE CÁLCULO



OBJETO DEL PROYECTO "CONSTRUCCION UCI DEL HOSPITAL SARARE DEL MUNICIPIO DE SARAVENA DEL DEPARTAMENTO DE ARAUCA"

CAPÍTULO	11	11.04.01	ITEM	OXIGENO MEDICINAL 1/2"	UNID.	UND	UBICACIÓN	HOSPITAL SARARE						
				FECHA	LOCALIZACIÓN	Dimensiones			No. Elemtnos	Medida Total				
						LONG	ANCHO	ALTO						
										32,00	32,00			
				SUB-TOTAL EJECUTADO										32,00

OBSERVACIONES:

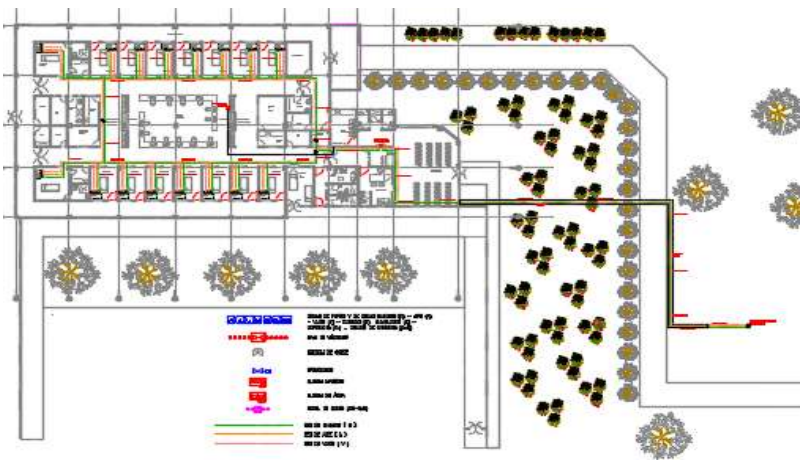

 Julian Camacho Reyes
 Ing. Civil Usta Tunja Tel:
 300-7019971

MEMORIA DE CÁLCULO

MEMORIA DE CÁLCULO													
OBJETO DEL PROYECTO		"CONSTRUCCION UCI DEL HOSPITAL SARARE DEL MUNICIPIO DE SARAVENA DEL DEPARTAMENTO DE ARAUCA"											
CAPÍTULO	11	11.04.02	ITEM	AIRE MEDICINAL 1/2"			UNID.	UND	UBICACIÓN	HOSPITAL SARARE			
				FECHA	LOCALIZACIÓN	Dimensiones			No. Elementos	Medida Total			
						LONG	ANCHO	ALTO					
										32,00	32,00		
SUB-TOTAL EJECUTADO										32,00			
OBSERVACIONES:													
 Julian Camacho Reyes Ing. Civil Usta Tunja Tel: 300-7019971													

MEMORIA DE CÁLCULO

OBJETO DEL PROYECTO "CONSTRUCCION UCI DEL HOSPITAL SARARE DEL MUNICIPIO DE SARAVENA DEL DEPARTAMENTO DE ARAUCA"

CAPÍTULO	11	11.04.03	ITEM	VACÍO 3/4"	UNID.	UND	UBICACIÓN	HOSPITAL SARARE						
					FECHA	LOCALIZACIÓN	Dimensiones			No. Elemtnos	Medida Total			
							LONG	ANCHO	ALTO					
										32,00	32,00			
										SUB-TOTAL EJECUTADO				

OBSERVACIONES:

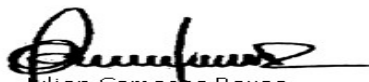
 Julian Camacho Reyes
 Ing. Civil Usta Tunja Tel:
 300-7019971

MEMORIA DE CÁLCULO

OBJETO DEL PROYECTO "CONSTRUCCION UCI DEL HOSPITAL SARARE DEL MUNICIPIO DE SARAVERENA DEL DEPARTAMENTO DE ARAUCA"

CAPÍTULO	12	12.01.01	ITEM	TUBERIA EN COBRE TIPO K DE 1/4"	UNID.	ML	UBICACIÓN	HOSPITAL SARARE		
				FECHA	LOCALIZACIÓN	Dimensiones			No. Elementos	Medida Total
						LONG	ANCHO	ALTO		
						36,00			1,00	36,00
				SUB-TOTAL EJECUTADO						36,00

OBSERVACIONES:



Julian Camacho Reyes
 Ing. Civil Usta Tunja Tel:
 300-7019971

MEMORIA DE CÁLCULO

OBJETO DEL PROYECTO

"CONSTRUCCION UCI DEL HOSPITAL SARARE DEL MUNICIPIO DE SARAVENA DEL DEPARTAMENTO DE ARAUCA"

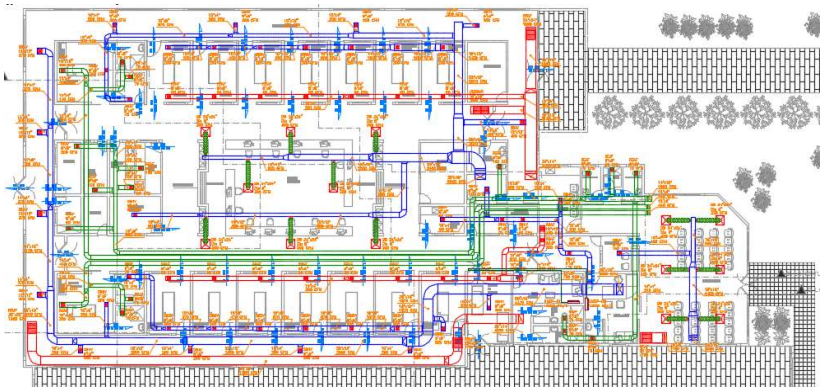

CAPÍTULO	12	12.01.02	ITEM	TUBERIA EN COBRE TIPO K 1/2"	UNID.	ML	UBICACIÓN	HOSPITAL SARARE			
					FECHA	LOCALIZACIÓN	Dimensiones				
							LONG	ANCHO	ALTO	No. Elementos	Medida Total
							74,00			1,00	74,00
					SUB-TOTAL EJECUTADO						74,00



OBSERVACIONES:

Julian Camacho Reyes
 Julian Camacho Reyes
 Ing. Civil Usta Funja Tel:
 300-7019971

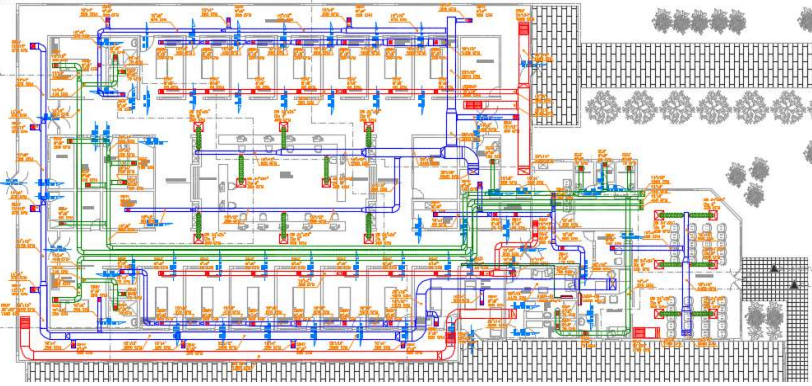
MEMORIA DE CÁLCULO

OBJETO DEL PROYECTO		"CONSTRUCCION UCI DEL HOSPITAL SARARE DEL MUNICIPIO DE SARAVERENA DEL DEPARTAMENTO DE ARAUCA"								
CAPÍTULO	12	12.01.03	ITEM	TUBERIA EN COBRE TIPO K 1 1/8"	UNID.	ML	UBICACIÓN	HOSPITAL SARARE		
				FECHA	LOCALIZACIÓN	Dimensiones			No. Elementos	Medida Total
				LONG	ANCHO	ALTO				
						38,00			1,00	38,00
				SUB-TOTAL EJECUTADO						38,00
OBSERVACIONES:										
 Julian Camacho Reyes Ing. Civil Usta Tunja Tel: 300-7019971										

MEMORIA DE CÁLCULO

OBJETO DEL PROYECTO

"CONSTRUCCION UCI DEL HOSPITAL SARARE DEL MUNICIPIO DE SARAVENA DEL DEPARTAMENTO DE ARAUCA"

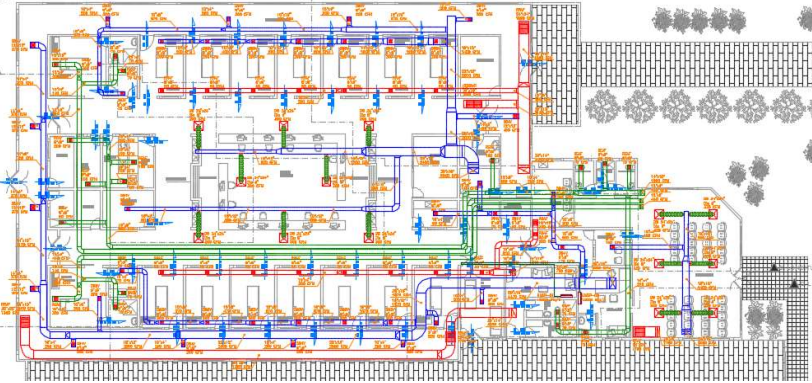
CAPÍTULO	12	12.02.01	ITEM	AISLAMIENTO TERMICO 1/4"	UNID.	ML	UBICACIÓN	HOSPITAL SARARE			
					FECHA	LOCALIZACIÓN	Dimensiones			No. Elementos	Medida Total
					LONG	ANCHO	ALTO				
						36,00				1,00	36,00
				SUB-TOTAL EJECUTADO							36,00

OBSERVACIONES:

 Julian Camacho Reyes
 Ing. Civil Usta Tunja Tel:
 300-7019971

MEMORIA DE CÁLCULO

OBJETO DEL PROYECTO "CONSTRUCCION UCI DEL HOSPITAL SARARE DEL MUNICIPIO DE SARAVERENA DEL DEPARTAMENTO DE ARAUCA"

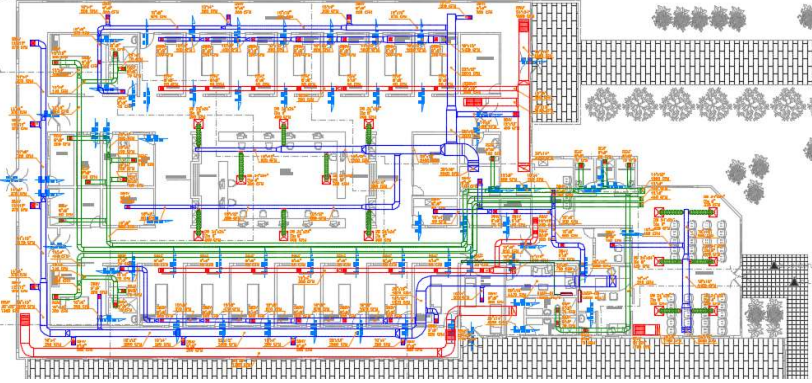
CAPÍTULO	12	12.02.02	ITEM	AISLAMIENTO TERMICO 1/2"	UNID.	ML	UBICACIÓN	HOSPITAL SARARE			
					FECHA	LOCALIZACIÓN	Dimensiones			No. Elementos	Medida Total
							LONG	ANCHO	ALTO		
							36,00			1,00	36,00
SUB-TOTAL EJECUTADO								36,00			

OBSERVACIONES:



 Julian Camacho Reyes
 Ing. Civil Usta Tunja Tel:
 300-7019971

MEMORIA DE CÁLCULO

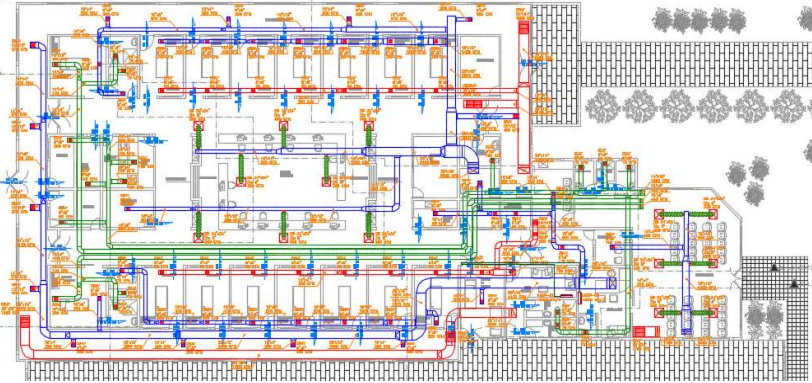
OBJETO DEL PROYECTO "CONSTRUCCION UCI DEL HOSPITAL SARARE DEL MUNICIPIO DE SARAVENA DEL DEPARTAMENTO DE ARAUCA"

CAPÍTULO	12	12.02.03	ITEM	AISLAMIENTO TERMICO 1/8"	UNID.	ML	UBICACIÓN	HOSPITAL SARARE			
					FECHA	LOCALIZACIÓN	Dimensiones			No. Elementos	Medida Total
					LONG	ANCHO	ALTO				
					38,00				1,00	38,00	
SUB-TOTAL EJECUTADO										38,00	

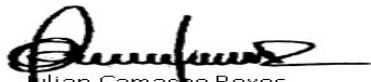
OBSERVACIONES:



 Julian Camacho Reyes
 Ing. Civil Usta. Tunja Tel:
 300-7019971

MEMORIA DE CÁLCULO

OBJETO DEL PROYECTO

"CONSTRUCCION UCI DEL HOSPITAL SARARE DEL MUNICIPIO DE SARAVENA DEL DEPARTAMENTO DE ARAUCA"

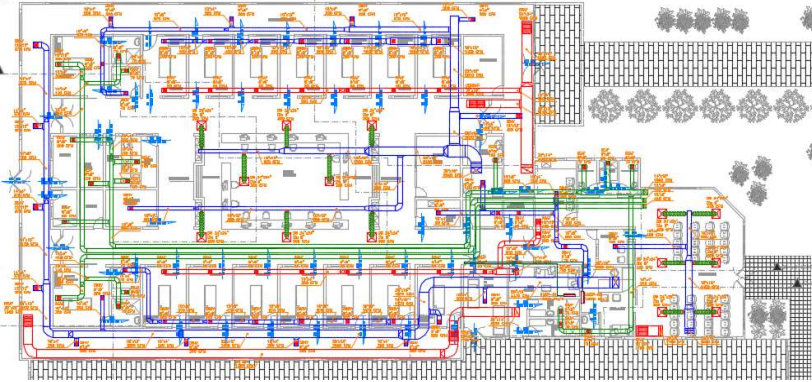

CAPÍTULO	12	12.03.01	ITEM	R-410A Refrigerante R410a, incluye: (Suministro, y Carga)	UNID.	LB	UBICACIÓN	HOSPITAL SARARE	
FECHA	LOCALIZACIÓN	Dimensiones			No. Elemtnos	Medida Total			
		LB	ANCHO	ALTO					
		90,00			1,00	90,00			
SUB-TOTAL EJECUTADO									90,00

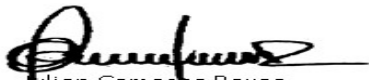

OBSERVACIONES:

 Julian Camacho Reyes
 Ing: Civil Usta. Tunja Tel:
 300-7019971

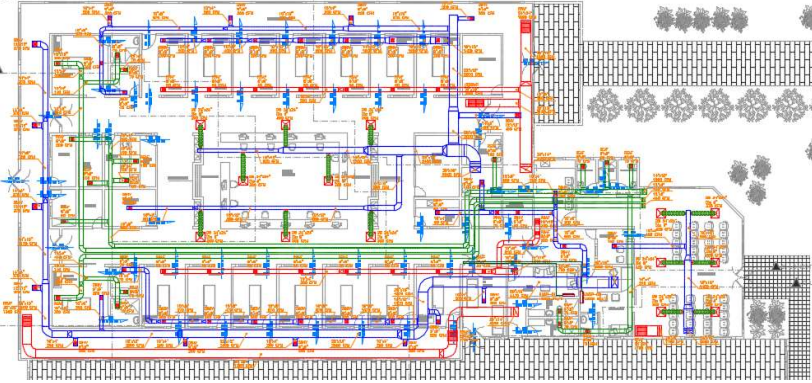
MEMORIA DE CÁLCULO

OBJETO DEL PROYECTO		"CONSTRUCCION UCI DEL HOSPITAL SARARE DEL MUNICIPIO DE SARAVENA DEL DEPARTAMENTO DE ARAUCA"												
CAPÍTULO	12	12.04.01	ITEM	MIRILLA DE LIQUIDO Filtro Secador 1/2"	UNID.	UND	UBICACIÓN	HOSPITAL SARARE						
				FECHA	LOCALIZACIÓN	Dimensiones			No. Elementos	Medida Total				
							LONG	ANCHO	ALTO					
										4,00	4,00			
SUB-TOTAL EJECUTADO										4,00				
OBSERVACIONES:														
 Julian Camacho Reyes Ing. Civil Usta Tunja Tel: 300-7019971														

MEMORIA DE CÁLCULO

OBJETO DEL PROYECTO

"CONSTRUCCION UCI DEL HOSPITAL SARARE DEL MUNICIPIO DE SARAVERENA DEL DEPARTAMENTO DE ARAUCA"

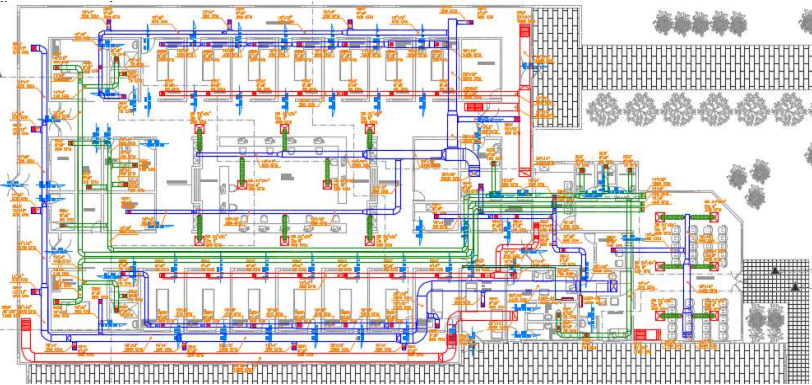

CAPÍTULO	12	12.05.01	ITEM	CAL. 24	UNID.	M2	UBICACIÓN	HOSPITAL SARARE			
					FECHA	LOCALIZACIÓN	Dimensiones			No. Elemtnos	Medida Total
							LONG	ANCHO	ALTO		
							236,00			1,00	236,00
					SUB-TOTAL EJECUTADO						236,00



OBSERVACIONES:

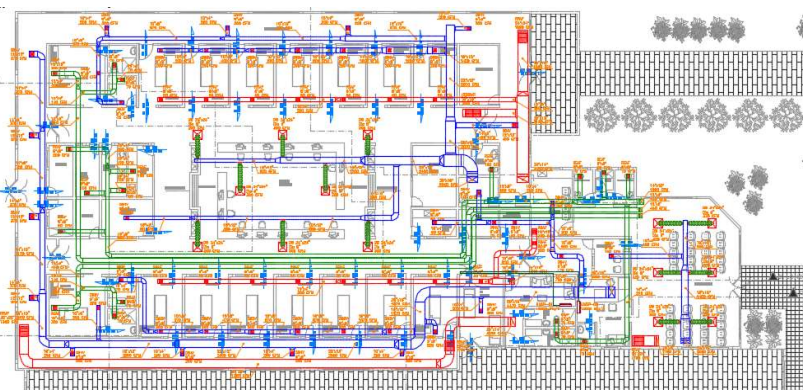

 Julian Camacho Reyes
 Ing. Civil Usta Tunja Tel:
 300-7019971

MEMORIA DE CÁLCULO

MEMORIA DE CÁLCULO														
OBJETO DEL PROYECTO		"CONSTRUCCION UCI DEL HOSPITAL SARARE DEL MUNICIPIO DE SARAVENA DEL DEPARTAMENTO DE ARAUCA"												
CAPÍTULO	12	12.06.01	ITEM	ESPESOR 20MM INTERIORES	UNID.	M2	UBICACIÓN	HOSPITAL SARARE						
				FECHA	LOCALIZACIÓN	Dimensiones			No. Elementos	Medida Total				
						LONG	ANCHO	ALTO						
						706,00				1,00	706,00			
				SUB-TOTAL EJECUTADO						706,00				
OBSERVACIONES:														
 Julian Camacho Reyes Ing. Civil Usta Tunja Tel: 300-7019971														

MEMORIA DE CÁLCULO

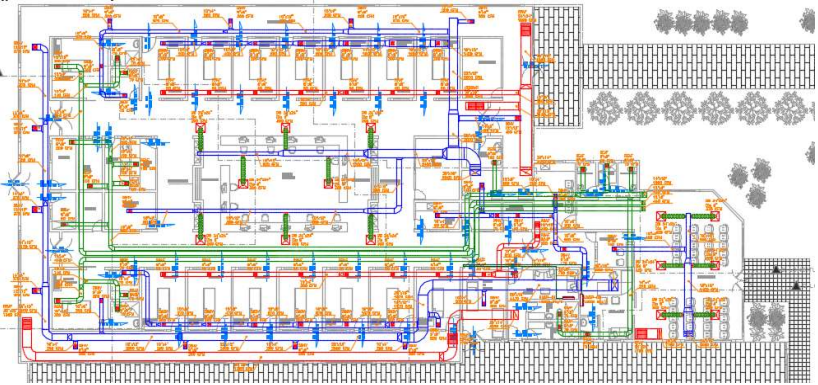
OBJETO DEL PROYECTO "CONSTRUCCION UCI DEL HOSPITAL SARARE DEL MUNICIPIO DE SARAVENA DEL DEPARTAMENTO DE ARAUCA"

CAPÍTULO	12	12.07.01	ITEM	DS4V 9"x9"	UNID.	UND	UBICACIÓN	HOSPITAL SARARE							
					FECHA	LOCALIZACIÓN	Dimensiones			No. Elementos	Medida Total				
							LONG	ANCHO	ALTO						
										17,00	17,00				
										SUB-TOTAL EJECUTADO					17,00

OBSERVACIONES:

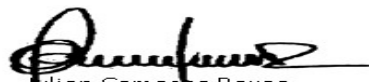
 Julian Camacho Reyes
 Ing. Civil Usta Funja Tel:
 300-7019971

MEMORIA DE CÁLCULO

OBJETO DEL PROYECTO "CONSTRUCCION UCI DEL HOSPITAL SARARE DEL MUNICIPIO DE SARAVENA DEL DEPARTAMENTO DE ARAUCA"

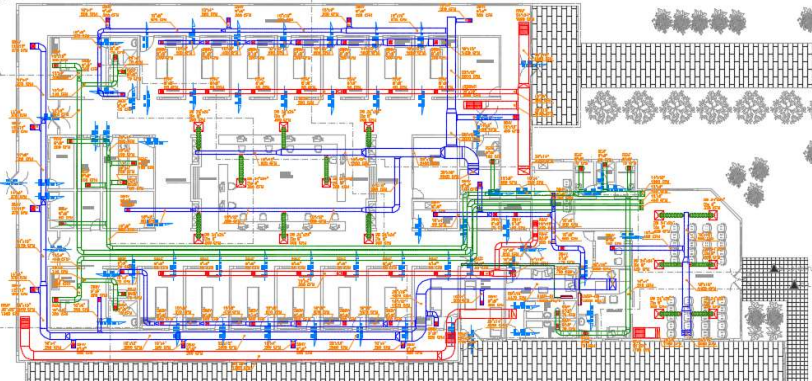
CAPÍTULO	12	12.07.02	ITEM	DS4V 12"x12"	UNID.	UND	UBICACIÓN	HOSPITAL SARARE						
					FECHA	LOCALIZACIÓN	Dimensiones			No. Elementos	Medida Total			
							LONG	ANCHO	ALTO					
										5,00	5,00			
					SUB-TOTAL EJECUTADO									

OBSERVACIONES:

 Julian Camacho Reyes
 Ing. Civil Usta Tunja Tel:
 300-7019971

MEMORIA DE CÁLCULO

OBJETO DEL PROYECTO "CONSTRUCCION UCI DEL HOSPITAL SARARE DEL MUNICIPIO DE SARAVENA DEL DEPARTAMENTO DE ARAUCA"

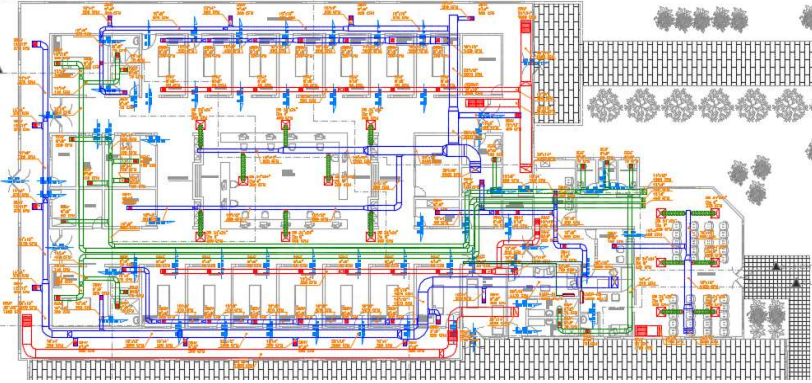
CAPÍTULO	12	12.08.01	ITEM	DS3V 9"x9"	UNID.	UND	UBICACIÓN	HOSPITAL SARARE						
					FECHA	LOCALIZACIÓN	Dimensiones			No. Elemtnos	Medida Total			
							LONG	ANCHO	ALTO					
										18,00	18,00			
					SUB-TOTAL EJECUTADO									

OBSERVACIONES:



 Julian Camacho Reyes
 Ing. Civil Usta Tunja Tel:
 300-7019971

MEMORIA DE CÁLCULO

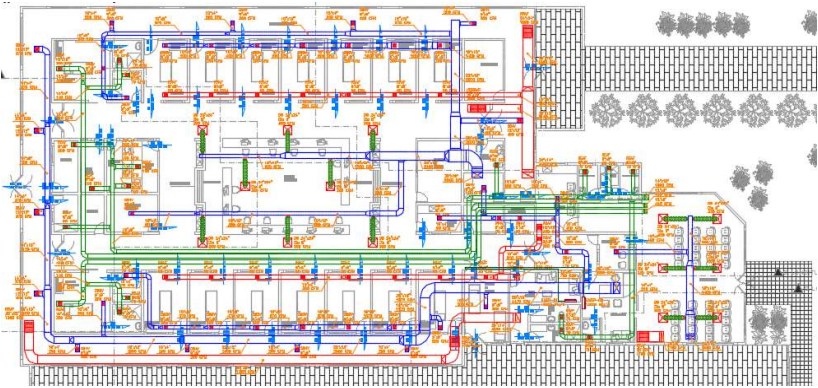
OBJETO DEL PROYECTO "CONSTRUCCION UCI DEL HOSPITAL SARARE DEL MUNICIPIO DE SARAVENA DEL DEPARTAMENTO DE ARAUCA"

CAPÍTULO	12	12.09.01	ITEM	DÍA 1/2"	UNID.	ML	UBICACIÓN	HOSPITAL SARARE			
					FECHA	LOCALIZACIÓN	Dimensiones			No. Elemtnos	Medida Total
							LONG	ANCHO	ALTO		
							30,00			1,00	30,00
					SUB-TOTAL EJECUTADO						30,00

OBSERVACIONES:

 Julian Camacho Reyes
 Ing. Civil Usta Tunja Tel:
 300-7019971

MEMORIA DE CÁLCULO

OBJETO DEL PROYECTO "CONSTRUCCION UCI DEL HOSPITAL SARARE DEL MUNICIPIO DE SARAVENA DEL DEPARTAMENTO DE ARAUCA"

CAPÍTULO	12	12.10.01	ITEM	DS 24"x24" Dia 8"	UNID.	UND	UBICACIÓN	HOSPITAL SARARE						
				FECHA	LOCALIZACIÓN	Dimensiones			No. Elementos	Medida Total				
						LONG	ANCHO	ALTO						
										14,00	14,00			
								SUB-TOTAL EJECUTADO						14,00

OBSERVACIONES:

Julian Camacho Reyes
 Ing. Civil Usta Tunja Tel:
 300-7019971

MEMORIA DE CÁLCULO

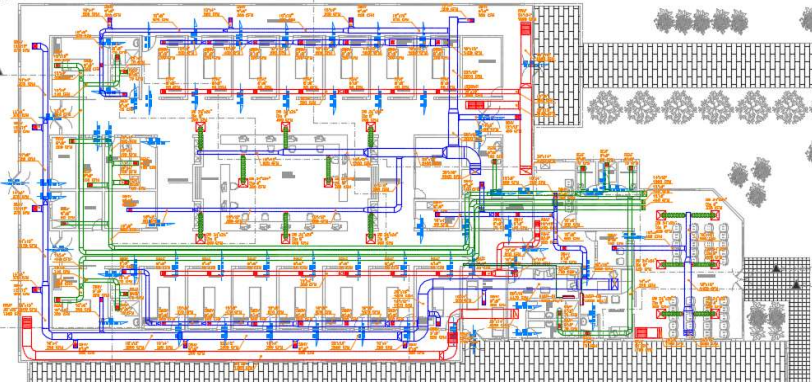

OBJETO DEL PROYECTO "CONSTRUCCION UCI DEL HOSPITAL SARARE DEL MUNICIPIO DE SARAVENA DEL DEPARTAMENTO DE ARAUCA"

CAPÍTULO	12	12.11.01	ITEM	REAF / RRAF 8"x8"	UNID.	UND	UBICACIÓN	HOSPITAL SARARE						
				FECHA	LOCALIZACIÓN	Dimensiones			No. Elementos	Medida Total				
						LONG	ANCHO	ALTO						
										32,00	32,00			
								SUB-TOTAL EJECUTADO						32,00

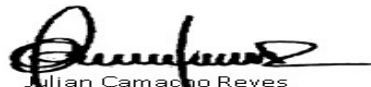
OBSERVACIONES:

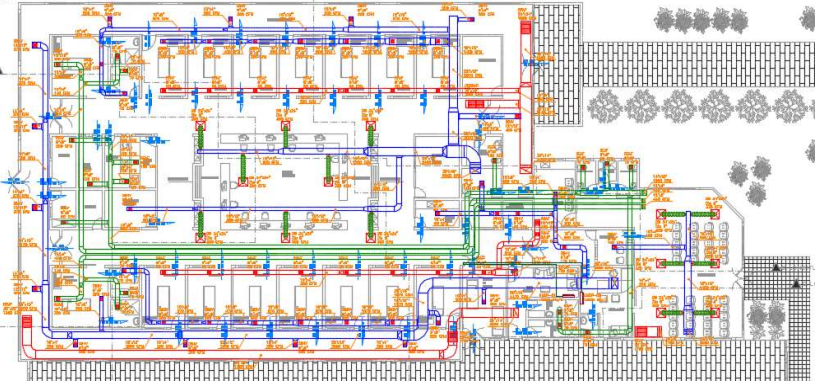

 Julian Camacho Reyes
 Ing. Civil Usta Tunja Tel:
 300-7019971

MEMORIA DE CÁLCULO

OBJETO DEL PROYECTO		"CONSTRUCCION UCI DEL HOSPITAL SARARE DEL MUNICIPIO DE SARAVENA DEL DEPARTAMENTO DE ARAUCA"											
CAPÍTULO	12	12.11.02	ITEM	REAF / RRAF 10"x10"	UNID.	UND	UBICACIÓN	HOSPITAL SARARE					
				FECHA	LOCALIZACIÓN	Dimensiones			No. Elementos	Medida Total			
						LONG	ANCHO	ALTO					
									3,00	3,00			
								SUB-TOTAL EJECUTADO					
OBSERVACIONES:													
 Julian Camacho Reyes Ing. Civil Usta Tunja Tel: 300-7019971													

MEMORIA DE CÁLCULO

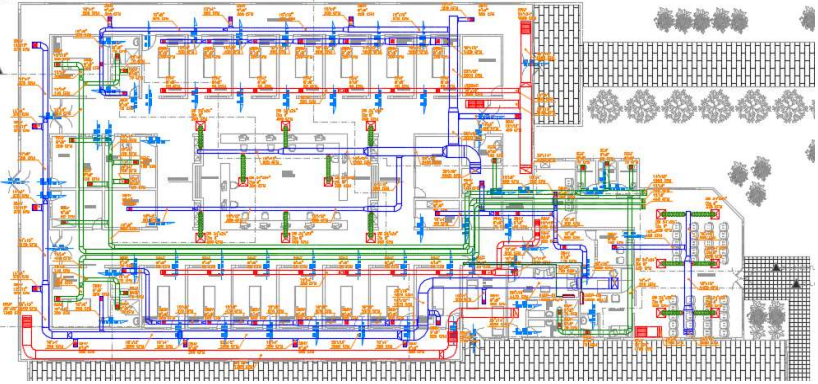
OBJETO DEL PROYECTO "CONSTRUCCION UCI DEL HOSPITAL SARARE DEL MUNICIPIO DE SARAVENA DEL DEPARTAMENTO DE ARAUCA"

CAPÍTULO	12	12.11.03	ITEM	REAF / RRAF 18"x18"	UNID.	UND	UBICACIÓN	HOSPITAL SARARE					
				FECHA	LOCALIZACIÓN	Dimensiones			No. Elementos	Medida Total			
						LONG	ANCHO	ALTO					
										2,00	2,00		
								SUB-TOTAL EJECUTADO					

OBSERVACIONES:

 Julian Camacho Reyes
 Ing. Civil Usta Tunja Tel:
 300-7019971

MEMORIA DE CÁLCULO

OBJETO DEL PROYECTO "CONSTRUCCION UCI DEL HOSPITAL SARARE DEL MUNICIPIO DE SARAVENA DEL DEPARTAMENTO DE ARAUCA"

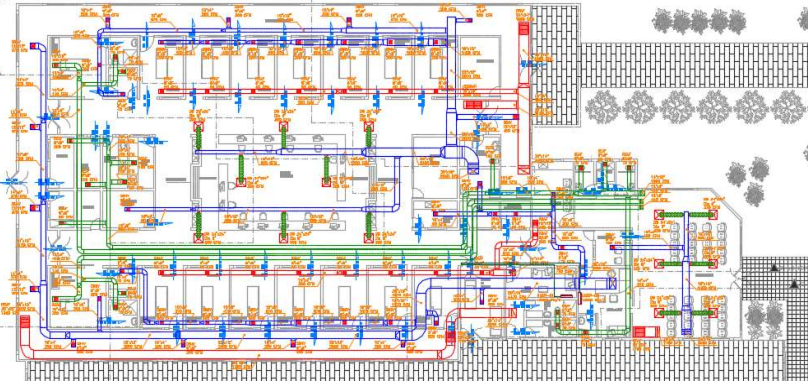
CAPÍTULO	12	12.11.04	ITEM	REAF / RRAF 22"x22"	UNID.	UND	UBICACIÓN	HOSPITAL SARARE					
				FECHA	LOCALIZACIÓN	Dimensiones			No. Elementos	Medida Total			
						LONG	ANCHO	ALTO					
										2,00	2,00		
				SUB-TOTAL EJECUTADO									2,00

OBSERVACIONES:



 Julian Camacho Reyes
 Ing. Civil Usta Tunja Tel:
 300-7019971

MEMORIA DE CÁLCULO

OBJETO DEL PROYECTO "CONSTRUCCION UCI DEL HOSPITAL SARARE DEL MUNICIPIO DE SARAVENA DEL DEPARTAMENTO DE ARAUCA"

CAPÍTULO	12	12.11.05	ITEM	REAF / RRAF 24"x24"	UNID.	UND	UBICACIÓN	HOSPITAL SARARE					
				FECHA	LOCALIZACIÓN	Dimensiones			No. Elemtnos	Medida Total			
						LONG	ANCHO	ALTO					
										2,00	2,00		
								SUB-TOTAL EJECUTADO					

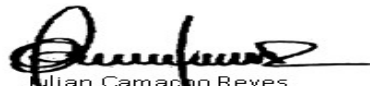
OBSERVACIONES:

 Julian Camacho Reyes
 Ing. Civil Usta Tunja Tel:
 300-7019971

MEMORIA DE CÁLCULO

OBJETO DEL PROYECTO "CONSTRUCCION UCI DEL HOSPITAL SARARE DEL MUNICIPIO DE SARAVENA DEL DEPARTAMENTO DE ARAUCA"

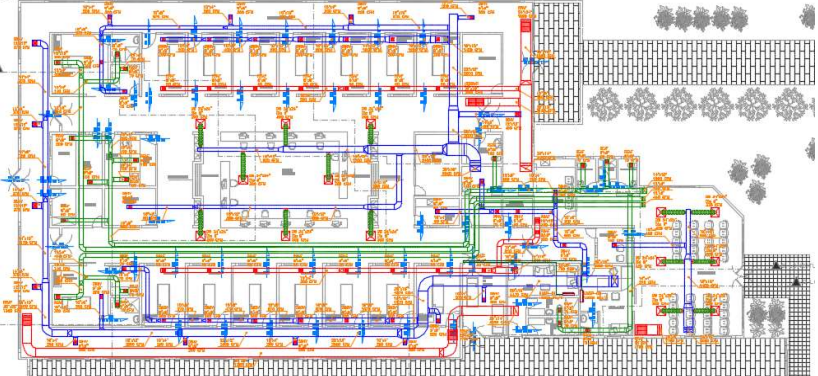
CAPÍTULO	12	12.12.01	ITEM	AD 8"	UNID.	UND	UBICACIÓN	HOSPITAL SARARE						
					FECHA	LOCALIZACIÓN	Dimensiones			No. Elementos	Medida Total			
							LONG	ANCHO	ALTO					
										14,00	14,00			
										SUB-TOTAL EJECUTADO				

OBSERVACIONES:



 Julian Camacho Reyes
 Ing. Civil Usta Tunja Tel:
 300-7019971

MEMORIA DE CÁLCULO

OBJETO DEL PROYECTO "CONSTRUCCION UCI DEL HOSPITAL SARARE DEL MUNICIPIO DE SARAVENA DEL DEPARTAMENTO DE ARAUCA"

CAPÍTULO	12	12.13.01	ITEM	MF 8"	UNID.	ML	UBICACIÓN	HOSPITAL SARARE			
					FECHA	LOCALIZACIÓN	Dimensiones			No. Elementos	Medida Total
							LONG	ANCHO	ALTO		
										28,00	
SUB-TOTAL EJECUTADO										28,00	

OBSERVACIONES:

 Julian Camacho Reyes
 Ing. Civil Usta Funja Tel:
 300-7019971

MEMORIA DE CÁLCULO

OBJETO DEL PROYECTO "CONSTRUCCION UCI DEL HOSPITAL SARARE DEL MUNICIPIO DE SARAVENA DEL DEPARTAMENTO DE ARAUCA"

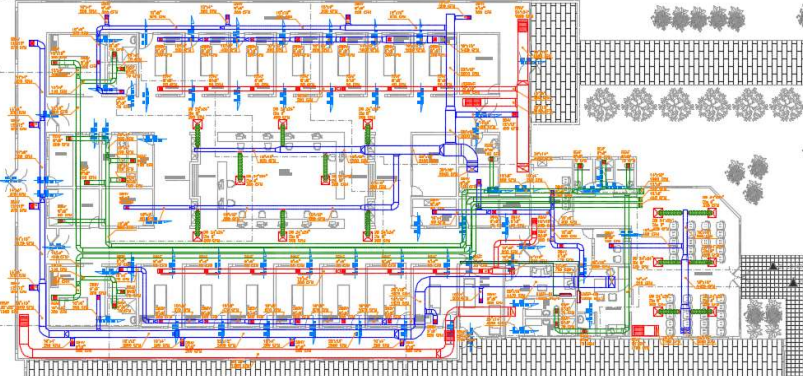
CAPÍTULO	12	12.14.01	ITEM	CB-03 2x18	UNID.	ML	UBICACIÓN	HOSPITAL SARARE					
					FECHA	LOCALIZACIÓN	Dimensiones			No. Elementos	Medida Total		
							LONG	ANCHO	ALTO				
													
							330,00				1,00	330,00	
					SUB-TOTAL EJECUTADO								

OBSERVACIONES:

 Julian Camacho Reyes
 Ing. Civil Usta Tunja Tel:
 300-7019971

MEMORIA DE CÁLCULO

OBJETO DEL PROYECTO "CONSTRUCCION UCI DEL HOSPITAL SARARE DEL MUNICIPIO DE SARAVENA DEL DEPARTAMENTO DE ARAUCA"

CAPÍTULO	12	12.15.01	ITEM	Dia 3/4"	UNID.	ML	UBICACIÓN	HOSPITAL SARARE						
					FECHA	LOCALIZACIÓN	Dimensiones			No. Elementos	Medida Total			
							LONG	ANCHO	ALTO					
							15,00					1,00	15,00	
					SUB-TOTAL EJECUTADO									15,00

OBSERVACIONES:



 Julian Camacho Reyes
 Ing. Civil Usta Tunja Tel:
 300-7019971

MEMORIA DE CÁLCULO

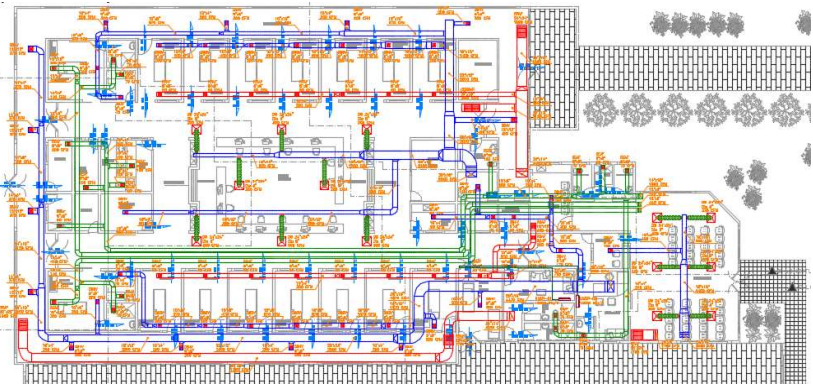
OBJETO DEL PROYECTO "CONSTRUCCION UCI DEL HOSPITAL SARARE DEL MUNICIPIO DE SARAVERA DEL DEPARTAMENTO DE ARAUCA"

CAPÍTULO	12	12.15.02	ITEM	Dia 1"	UNID.	ML	UBICACIÓN	HOSPITAL SARARE			
					FECHA	LOCALIZACIÓN	Dimensiones			No. Elementos	Medida Total
							LONG	ANCHO	ALTO		
										35,00	
					SUB-TOTAL EJECUTADO					35,00	

OBSERVACIONES:

 Julian Camacho Reyes
 Ing. Civil Usta Tunja Tel:
 300-7019971